

LED batten

A fast install and versatile IP20 batten with press release buttons for quick opening and installation. Reliable integrated LED technology, ensuring maintenance-free installation and a long lifetime. Homogeneous illumination. Direct replacement for conventional battens in terms of light performance and length. Piano-key terminals, enabling loop-in loop-out. ENEC certified driver. Body: sheet metal, white finish (RAL 9002). Diffuser: polycarbonate, opal. End caps: polycarbonate, white (RAL 9002). Weight: 4,3 kg

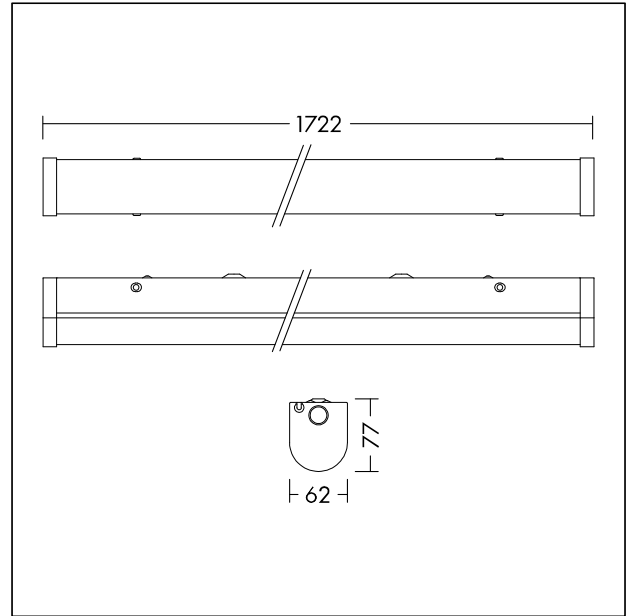

TE_POPPY_F_persp.jpg



TE_POPPY_M_1800.wmf

Light Distribution

STD - standard

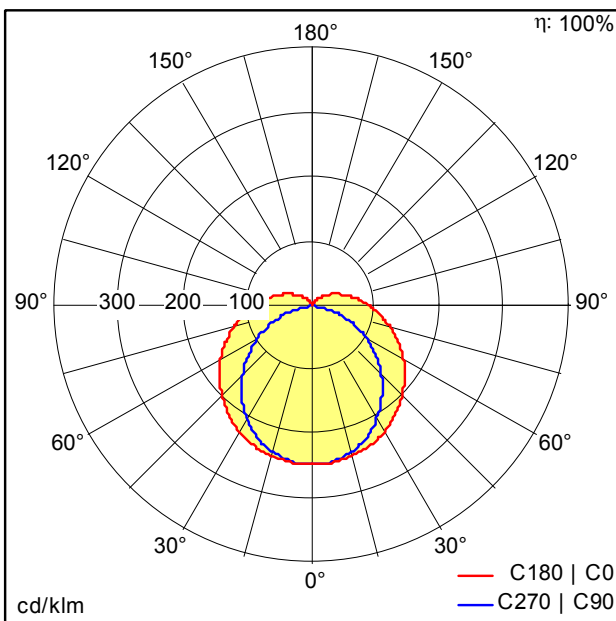

TE_POPPY_LED_1800_8500_840.idt

- Light Source: LED
- Luminaire luminous flux*: 8508 lm
- Luminaire efficacy*: 106 lm/W
- Colour Rendering Index min.: 80
- Correlated colour temperature: 4000 Kelvin
- Chromaticity tolerance (initial MacAdam): 5
- Rated median useful life*: L70 50000h at 25°C
- Ballast: 1x LED_Con
- Luminaire input power*: 80 W Power factor = 0.9
- Dimming: Fixed output

All values marked with an * are rated values. Unless stated otherwise, the values apply to an ambient temperature of 25°C.