

aperta

EZTAG3 | PROXIMITY AND KEYPAD DOOR ENTRY



USER MANUAL



www.espuk.com



System Components



Proximity and Keypad Reader

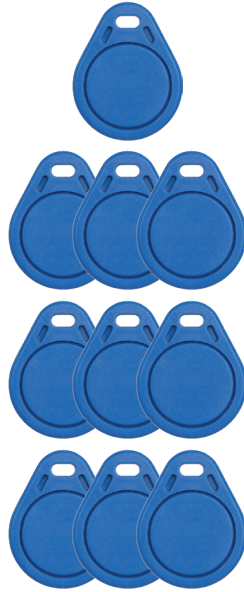

10 x Proximity Tags



1 x Hex Key
4 x Plastic wall plug
4 x Countersunk screws
1 x Diode and 1 x Capacitor

Optional Accessories



EVBPSBB
Lock Power Supply



EV-EXIT
Push to Release



EV-EBG
Emergency Release



EV-ML-250/500XT
Electro-magnetic Lock



ENTERD
Electric Lock





Contents

Installation	4
EZTAG3 Wiring Example 1	5
EZTAG3 Wiring Example 2	5

Advanced Programming Guide

How to set-up Access Pin Number	6
How to set-up Access Tags	6
Deleting Access Pin or Tag	7
Changing Programming Pin	7
Clear all Pin and Tag Data	8
Default to Factory Settings.....	8
Lock 1 Output Operating Time	9
Enable 'Door Bell' Facility	9
Enable 'Tamper Alarm' facility	10
Access Pin Number for Lock 2 Output	10
Deleting Access Pin for Lock 2	11
Lock Output Operating Time for Lock 2 Output.....	11
System setup record	12
User Guide.....	14
Technical Specification	14



Installation



↑
Release hex screw from the bottom of the keypad

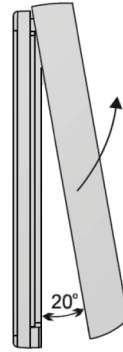

(Side View)
Push the keypad up to release from mount plate

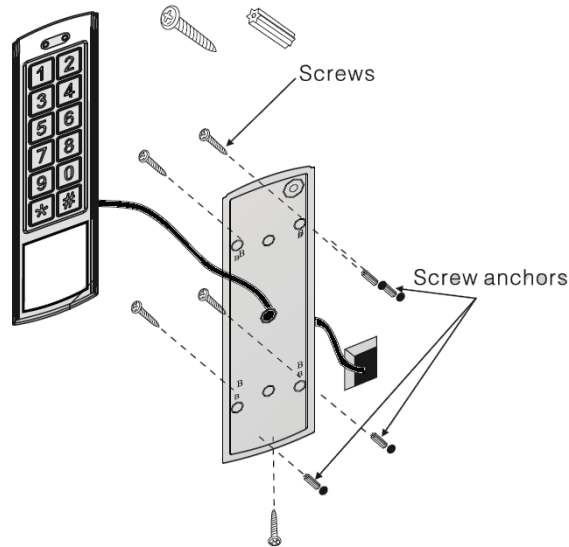

Thread system cable through the cable entry hole then make the system connections (as per the wiring diagram), mount the bracket to the surface and slide the keypad to the mountplate, re-fit the hex screw to secure into position.

Note: if using more than one keypad, ensure that the keypads are mounted a minimum 185cm apart



EZTAG3 Wiring Example 1

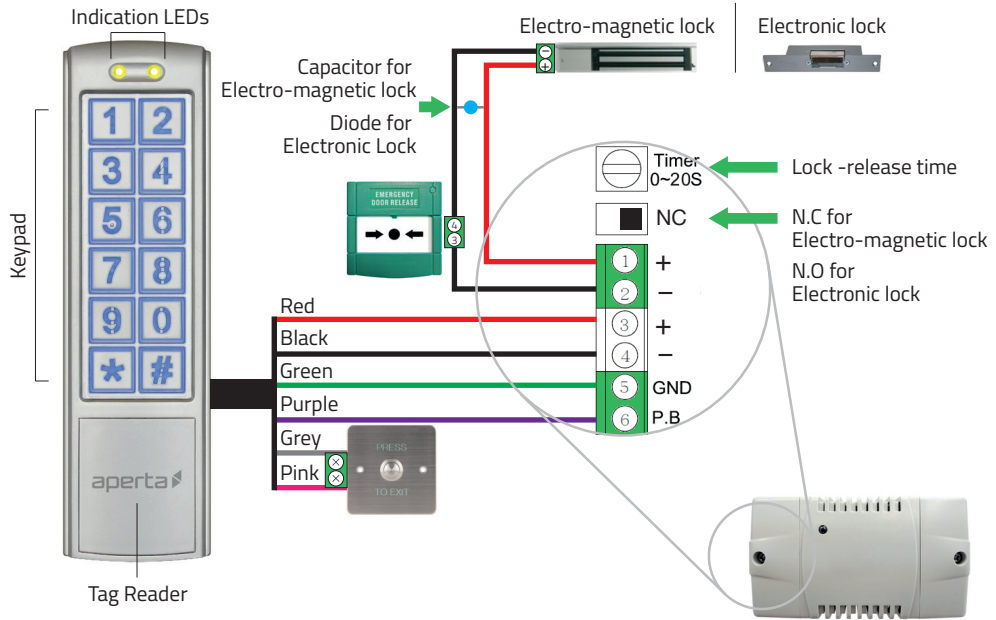



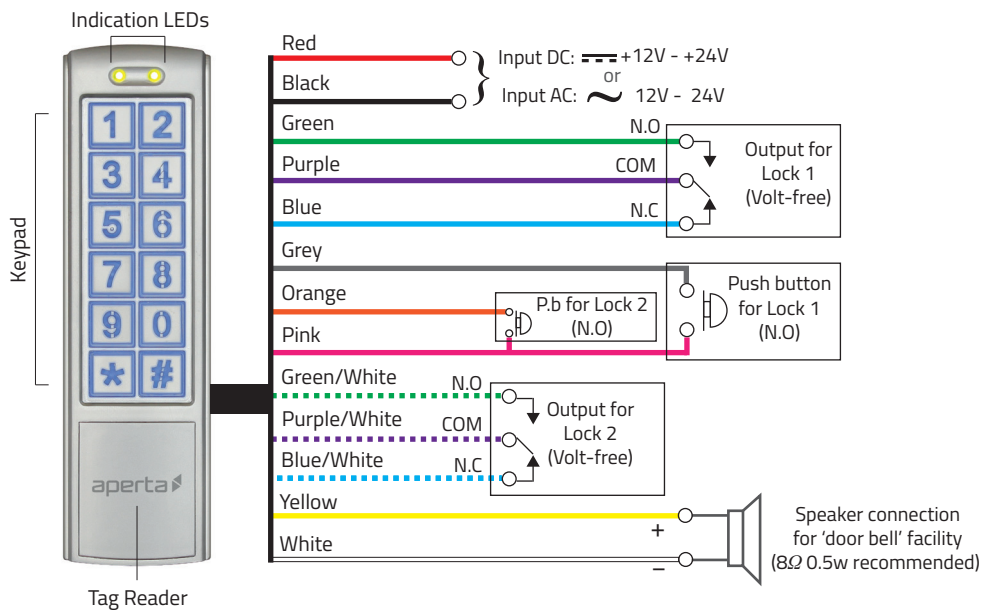





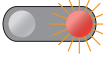

EZTAG3 Wiring Example 2











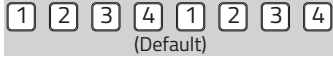

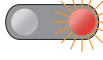



How to set-up Access Pin Number

Step Number	Action	Keypad Indication
1	Enter Programming  (Default)	 Long Tone
2		
3		 Long Tone
4	Enter a starting location number 	 Double Tone
5	 Enter a 4 digit pin <small>(1234 not be used)</small>	 Long Tone
6	 To end programming	

How to set-up Access Tags







Step Number	Action	Keypad Indication
1	Enter Programming  (Default)	 Long Tone
2		
3		 Long Tone
4	Enter a unused location number* 	 Long Tone
5	 Enter number of tags to be registered	 Tone
6	 Present the tag with the lowest serial number	 Tone
7	All other batch tags will auto register  To end programming	

*Each tag will use up a location number

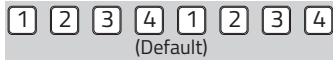

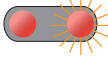







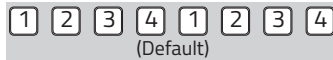

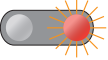
Deleting Access Pin or Tag

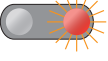
Step Number	Action	Keypad Indication
1	Enter Programming 	 Long Tone
2	Enter the location number of tag/pin 	
3	 To delete	
4	 To end programming	

Changing Programming Pin







Step Number	Action	Keypad Indication
1	Enter Programming 	 Long Tone
2		
3	 Enter new 4 digit programming pin	
4	 Re-enter new 4 digit programming pin	 Long Tone
5	 To end programming	

Note; To access keypad's programming mode, the 4 digit programming code is entered in twice



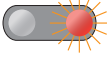





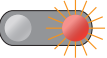

Clear all Pin and Tag Data

Step Number	Action	Keypad Indication
1	Enter Programming 	 Long Tone
2		
3		 Long Tone
4	 To end programming	







Default to Factory Settings

Step Number	Action	Keypad Indication
1	Enter Programming 	 Long Tone
2		
3		 Long Tone
4	 To end programming	

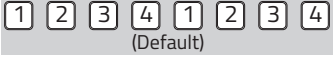

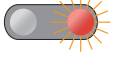







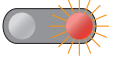

Lock 1 Output Operating Time

Step Number	Action	Keypad Indication
1	Enter Programming  (Default)	 Long Tone
2		
3	Enter number of seconds 00-99 	 Long Tone
4	 To end programming	









Enable 'Door Bell' Facility

Step Number	Action	Keypad Indication
1	Enter Programming  (Default)	 Long Tone
2		
3	 To enable  To disable	 Long Tone
4	 To end programming	

 Becomes the 'door bell' push in normal mode











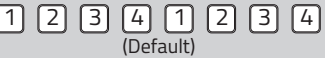

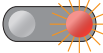
Enable 'Tamper Alarm' facility

Step Number	Action	Keypad Indication
1	Enter Programming  (Default)	 Long Tone
2		
3	 To enable  To disable	 Long Tone
4	 To end programming	

Tamper alarm activates the keypad's internal buzzer and 'door bell' output if the light sensor is exposed







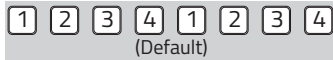

Access Pin Number for Lock 2 Output

Step Number	Action	Keypad Indication
1	Enter Programming  (Default)	 Long Tone
2		
3		 Long Tone
4	Enter an unused location number 	 Double Tone
5	 Enter a 4 digit pin <small>(1234 should not be used)</small>	 Long Tone
6	 To end programming	

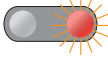







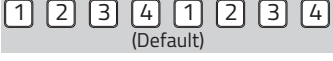

Deleting Access Pin for Lock 2

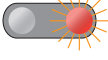
Step Number	Action	Keypad Indication
1	Enter Programming  (Default)	 Long Tone
2		
3	Enter the location number of pin 	
4	 To delete	
5	 To end programming	

Lock Output Operating Time for Lock 2 Output

Step Number	Action	Keypad Indication
1	Enter Programming  (Default)	 Long Tone
2		
3	Enter number of seconds 00-99 	 Long Tone
4	 To end programming	



User Guide

To release Lock 1

(A)
Enter a programmed
Access Pin number



(B)
Present a
registered tag



To access programming mode

1 2 3 4 1 2 3 4
(Default)

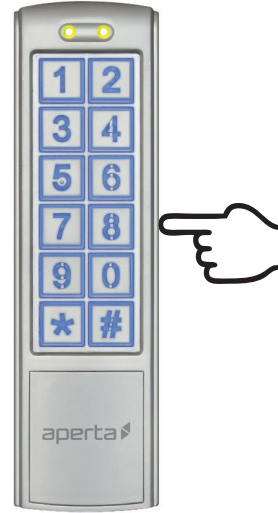

Technical Specification

DC input	12 - 24volts
AC input	12 - 24volts
Standby current	80ma
Operating current (without lock)	110ma

Working temperature	-20c to +50c
Reader frequency	125KHz
IP rating	65
Dimension	150 x 44 x 24mm







Elite Security Products
Unit 7, Target Park, Shawbank Rd
Lakeside, Redditch B98 8YN



Telephone: 01527 51 51 50
Fax: 01527 51 51 43
email: info@espuk.com

www.espuk.com

