

atc[®]

Energy Efficient
Electric Heating, Hand Dryers
& Ventilation

Catalogue Index

We are ATC

Our Story	2
Timeline	3
Sustainability	4
Our Vision	6
The ATC Experience	7
ATC Academy	8



Energy Efficient Hand Dryers 12

Which Hand Dryer to Use	14
FAQs	15
Tiger ECO High Speed Hand Dryer	16
Cheetah High Speed Hand Dryer	18
Puma High Speed Hand Dryer	20
Cub High Speed Hand Dryer	22
Panther ECO High Speed Hand Dryer	24
Premium Blade High Speed Hand Dryer	26
ECO Tap Washroom Range	28
Dahlia Soap & Sanitiser Dispenser	30
Choose Hygiene. Choose HEPA.	32
Cost Savings	33
C02 Impact on the Environment	36



Thermal Electric Radiators 38

Thermal Electric Radiator Technology	40
Key Features of ATC Thermal Electric Radiators	44
ATC Smart Technology	45
Sizing Guide	46
The Smart RF Family	48
Sun Ray RF Thermal Electric Radiators	56
iLifestyle Thermal Electric Radiators	60
Merida RF Digital Panel Radiators	66
Neptune Low Level Radiators	68
Almeria ECO Digital Panel Heaters	70
Thermal Radiator Features	72



Electric Heating Range 74

What is Radiant Heating?	76
Underfloor Heating	78
HeatStat Digital Thermostat	80
Nexum RF Digital Thermostat	82
Pacific Towel Radiators	84
Bavaro Downflow Heater	90
Mirror Defog Heaters	92
Bathroom Range	94
Welcome Overdoor Heater	96
Radiant Ceiling Heaters	98
Hot Top Radiant Heater	102

	Outdoor Heating Range	104		Industrial Ventilation	152
	Alfresco	106		Vortical A-E Range	153
	Riviera	108		Table of Air Changes by Room Type	156
	Sienna	110		Easi Vent Ducting	157
	Optional Mounting Brackets	112		Ducting & Accessories Rectangular	158
	Bluetooth Heating Controller	114		Ducting & Accessories Round	160
	Heating Areas	116		Ducting & Accessories Flexible	161
	Cost Savings	118		Wall Grilles	162
				Ducting Accessories	163
	Domestic Ventilation	122		Water Heaters & Boilers	164
	Punto Standard Fans	124		Pacific Water Heaters	166
	Punto EVO Fans	126		Installation Information	170
	Punto Filo Fans	128		Why Use Unvented Water Heaters	171
	Punto Ghost Fans	129		Instantaneous Water Heater	172
	Record M10/4T Fan	130		Presto ECO Boil	174
	Domestic Centrifugal Ventilation	132		Heating Design Service	176
	Quadro Fan Range	134		Extras	
	Ariett Fan Range	138		Brochure Range	180
	Angol & Axial K Fans	139		Find your Local Sales Rep	182
	Commercial Ventilation	140		Spare Parts	183
	Vario Window / Wall Fans	142			
	Lineo Fans Range	144			
	CA In Line Fans Range	148			
	Nordik Ceiling Sweep Fan	150			
	Gordon Wall Mounted Oscillating Fan	150			
	Controllers & Environmental Sensors	151			

Our Story

ATC was established in 1991, and since then we have evolved into a solution-oriented company, designing, developing, producing and distributing Energy Efficient products in response to market needs.

We are focused on customer service and support and we strive to ensure a high level of dialogue-based cooperation with our customers.

Quality

Quality, safety and design are the key elements of ATC products. It is the core of our business and it ensures our customers' confidence in our products too.

Our Products

We are very proud that our products are being used in many different types of applications. We started in Ireland but in recent years our products can also be found in the United Kingdom and mainland Europe. We look forward to continuing our expansion into existing and new markets.

Innovation

Since 1991 there have been many advancements and changes in product development and technologies. There also have been many changes in the way people carry out and transact their business.

We have embraced and taken on many of these new technologies. However, our strength lies in our know-how and company structure, which allows us to respond quickly and flexibly to both specific and generalised customer requests.

Quality Makes the Difference



1991

ATC Opens for business at the Dunlop Centre, Adelaide Road as exclusive partners to Vortice Ventilation & Omron Electronics



1994

Due to business development & growth, ATC moved to a larger premises in Walkinstown, Dublin



1996

Due to business growth, ATC moved again to a larger premises in Tallaght, Dublin



2008

ATC opened its new head quarters at Broomhill Drive, Tallaght



1992

ATC Employed our very first External Sales Representative



1995

ATC achieved ISO 9001 Accreditation



2001

Incorporation of ATC Automation as a Division within the Group



2009

ATC Automation appointed Omron Premium Partner Status



2014

ATC commences business in the UK



2015

Created our new Product Development & Quality Department to grow and expand the ATC range of energy efficient products

2017

Open our new UK Distribution Centre to improve and provide Next Day Service to our UK Customers



2012

The launch of the first ATC Branded Products in the market



2014

Open our first Energy Showrooms at ATC House



2016

25 Years in Business!



2017

ATC Lifestyle Radiator crowned the Winner of the EIFI Energy Efficient Product of the Year



2019

ATC won the EIFI Project of the Year for the installation of the Sun Ray Radiators at Aungier Street Student Accommodation



2019

Improving efficiencies and service with our 5S Accreditation



2021

- Celebrating 30 Years of ATC
- ATC House reopens after Covid-19 pandemic
- ATC Academy opens for visitors
- Sustainable FSC product boxes are adopted for selected products



2019

Official Opening of the Energy Efficient Showroom & Training Hub at ATC House



2020

Introduction of the ATC Smart Logo for our new & developing range of Smart Products



2022

ATC Wins Distributor of the Year at Ireland's Electrical Awards

ATC & Sustainability

Recyclable Packaging

We have recently adopted new FSC Certified cardboard packaging for selected products, The Forest Stewardship Council (FSC) is committed to protecting forests for future generations and helping to combat climate change.

Bleaches and pigments have been eliminated from this packaging reducing chemical waste which is a harmful pollutant.



100% Recycled Aluminium

All of the aluminium used in the manufacturing process is 100% recycled aluminium, contributing to a circular economy and minimising the exhaustion of natural sources. Just 5% of energy is used through the production of recycled aluminium.



WEEE

Our electrical products are recyclable through WEEE – Waste Electrical and Electronic Equipment recycling, which allows valuable resources including plastics, metals and glass to be recovered for further use in manufacturing and ensures hazardous waste is disposed of safely, helping to protect our environment.

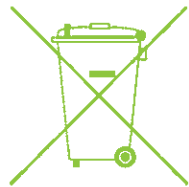

ROHS

All of our products are RoHS compliant, in conjunction with the EU's RoHS Directive for restricting the use of hazardous substances in electrical equipment to protect the environment and public health.

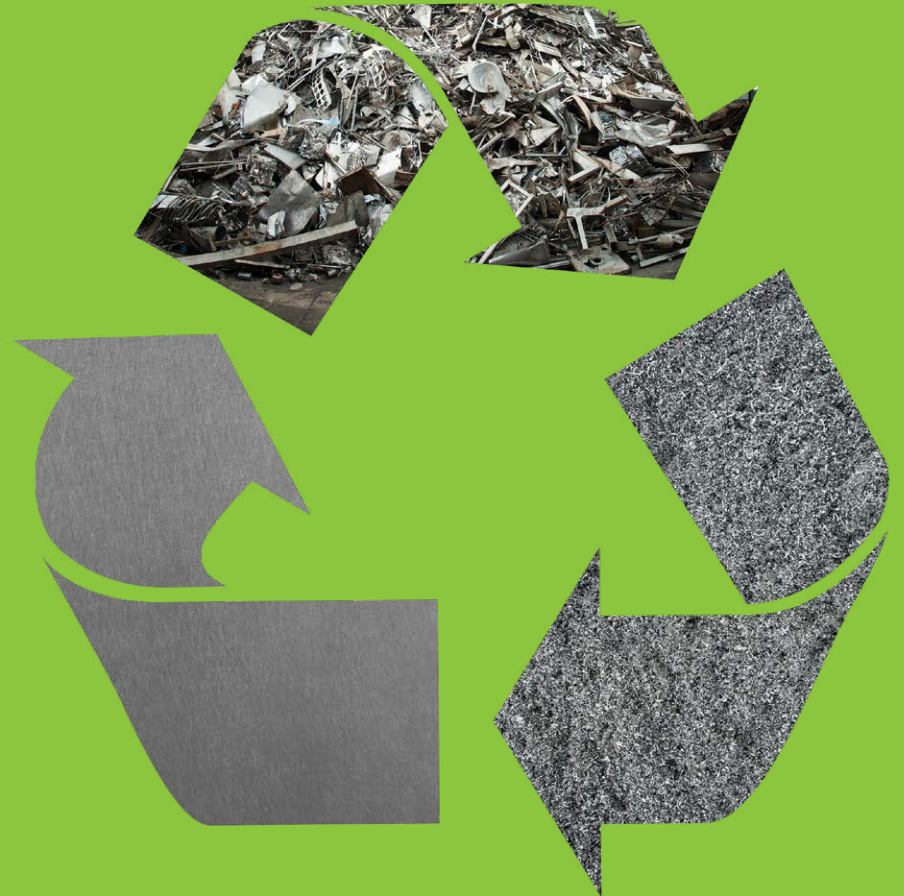

Our Vision

Our strategic vision is to create and sustain **positive long term relationships** with our customers by helpful, **effective response** to their ongoing requirements by providing the most up-to-date and **innovative products** and support in a constantly changing environment and market.





Our Core Values of **Quality, Service,** and **Customer Care** are primary to our day-to-day activities

Book a visit to the ATC Academy and Energy Showroom



Your team will avail of professional development & product training delivered by our team of Technical Specialists.



Contact marketing@atc.ie to arrange your visit

atc[®]

Your Heating Partner



amazon alexa

Google Assistant



Wi-Fi Heaters Outdoor Heaters Bathroom Range

Digital Heaters Commercial Heaters Thermostats and Controllers



Next Day Delivery Across Ireland*



353 (1) 467 8301 | sales@atc.ie | [atc.ie](https://www.atc.ie)

*For orders placed by 2.30pm



Energy Efficient Hand Dryers

Which Hand Dryer to Use	14
Frequently Asked Questions	15
Tiger ECO High Speed Hand Dryer	16
Cheetah High Speed Hand Dryer	18
Puma High Speed Hand Dryer	20
Cub High Speed Hand Dryer	22
Panther ECO High Speed Hand Dryer	24
Premium Blade High Speed Hand Dryer	26
ECO Tap Washroom Range	28
Dahlia Soap & Sanitiser Dispenser	30
Choose Hygiene. Choose HEPA.	32
Cost Savings	33
CO ₂ Impact on the Environment	36

Did you Know?
1 ton of paper towels
is the equivalent of
17 trees

Dry your Hands the Eco-Friendly Way



electric Handdryer
Association

Which Hand Dryer to use?

We provide the most comprehensive range of Energy Efficient Hand Dryers on the market

	Tiger ECO	Cheetah	Puma	Cub	Panther ECO	Premium Blade
Energy Efficient with Low Running Costs	●	●	●	●	●	●
Variable Outputs KW	650/1400	1550	600/1300	600/1300	700/1400	700/2000
HEPA Filtration	Optional				●	●
Air Filtration	●	●	●	●	●	●
UV Sterilisation			●			●
Drying Time	15 Seconds	15 Seconds	15 Seconds	15 Seconds	15 Seconds	15 Seconds
Low Usage			●	●		
Medium Usage	●	●				●
High Usage	●				●	
Vandal Resistant					●	
Approvals	UKCA, CE, GS	UKCA, CE, GS	UKCA, CE, GS	UKCA, CE, GS	UKCA, CE, GS	UKCA, CE, GS
Warranty	2 Years	2 Years	2 Years	1 Year	5 Years	3 Year

ECO Tap

Washroom Range
Experience Unique



Soap Dispenser

Automatic Water Tap

High Speed Hand Dryer



Frequently Asked Questions

What's the difference between the High Speed Cub and the Tiger Eco Hand Dryers?



High Speed Cub

Tiger ECO

15 second drying time	✓	✓
LED countdown indicator	✓	✓
Low running costs	✓	✓
Available in various finishes	✓	✓
Suited to areas of low traffic	✓	—
Suited to areas of medium to high traffic	—	✓
Switchable heating element on/off	✓	✓
Compact high speed hand dryer	✓	—
Optional HEPA filter available	—	✓
Long life brush motor	—	✓

ATC Tiger ECO

High Speed Hand Dryer

Ultra modern design



Key Features Include:

- 15 second drying time
- Low running costs
- Suitable for areas of medium to high traffic
- Switchable heating output
- HEPA filter (Optional)
- LED Countdown Indicator
- Available in brushed stainless steel or white
- Long life brush motor





Sleek high speed hand dryer perfect for areas of medium to high footfall. The optional HEPA filter captures 99.9% of bacteria for effective and efficient hand drying.

Description

Product Code	Z-3145M	Z-3145W
Finish	Stainless Steel	White
Warranty	2 Years	2 Years
Activation	Automatic	Automatic
Cover Material	Stainless Steel	Painted Steel

Electrical Specifications

Voltage	220/240V
Frequency (Hz)	50Hz
Motor Type	Brushed Motor
Power Output	1400 Watts
Motor Power	650 Watts
Heating Power	750 Watts/off
Amps	5.5A
Sensor Adjustable	Fixed
Drying Time	15 seconds
Air Speed	70m/s
Air Volume	122.4m ³ /h
Filter	Filter Included

Optional HEPA Filter removes 99.9% of particles down to 0.3µm

Noise Level

70dB(A) @1m

Approvals



Safety Features

Motor Thermal Protection	100°C
Heater Thermal Protection	100°C
Time Protection	45 seconds
Cover Screws	Vandal Resistant
Protection	IP13

Dimensions and Weight

Width	312mm
Height	302mm
Depth	172mm
Weight	4.1kg



Commercial



Hospitality



Sports & Leisure



Healthcare



Education



Dries Hands in 15 Seconds



Annual CO₂ Emissions



Saving Energy
Reducing the
Carbon Footprint



Optional HEPA Filter



YEAR WARRANTY

[RETURN TO INDEX](#)

ATC **Cheetah** High Speed Hand Dryer

Elegant, hygienic and cost effective



Key Features Include:

- 15 second drying time
- Low running costs
- Suitable for areas of medium traffic
- Available in brushed stainless steel, black or white





A durable high speed hand dryer, perfect for areas of medium level footfall, such as service stations or convenience stores.

Description

Product Code	Z-2281M	Z-2281W	Z-2281B
Finish	Stainless Steel	White	Black
Warranty	2 Year	2 Year	2 Year
Activation	Automatic	Automatic	Automatic
Cover Material	Stainless Steel	Painted Steel	Painted Steel

Electrical Specifications

Voltage	220/240V
Frequency (Hz)	50 / 60Hz
Motor Type	Brush Type
Power Output	1550 Watts
Motor Power	650 Watts
Heating Power	900 Watts
Amps	6.6Amps
Sensor	Fixed
Drying Time	15 seconds
Air Speed	65 m/s
Air Volume	133m3/h
Filter	Filter Included

Noise Level

75dB (at 1m)

Approvals



Safety Features

Motor Thermal Protection	Turns unit off at 135°C
Heater Thermal Protection	Turns unit off at 142°C
Time Protection	45s Auto Shut Off
Cover Screws	Vandal Resistant
Protection	IPX1

Size and Weight

Width	295mm
Height	320mm
Depth	170mm
Weight	4.5kg



Commercial



Hospitality



Sports & Leisure



Healthcare



Education



Dries Hands in
15 Seconds



Annual CO₂
Emissions



Saving Energy
Reducing the
Carbon Footprint



YEAR
WARRANTY

[RETURN TO INDEX](#)

ATC **Puma** High Speed Hand Dryer

Low energy, compact design



Key Features Include:

- 12–15 second drying time
- Low running costs
- Suitable for areas of low traffic
- Switchable heating output
- Anti-Bacterial UV Sterilisation
- Durable Stainless Steel
- Compact design



A sleek and compact high speed hand dryer ideal for single use washrooms in areas of low footfall.

Description

Product Code	Z-2000M
Cover Material	Stainless Steel
Finish	Matt Stainless Steel
Warranty	2 Years
Activation	Automatic

Electrical Specifications

Voltage	220/240V
Frequency (Hz)	50 / 60Hz
Brush Motor	25000 rpm
Power Output	1300 Watts
Motor Power	600 Watts
Heating Power (adjustable)	700 W / Off
Amps	6.6Amps
Sensor	250mm Fixed
Drying Time	15 seconds
Air Speed	65 m/s

Noise Level	70db at 1m
--------------------	------------

Approvals	UK CA CE GS
------------------	-------------

Safety Features	
Motor Thermal Protection	Turns unit off at 100°C
Heater Thermal Protection	Turns unit off at 100°C
Time Protection	45s Auto Shut Off
Cover Screws	Vandal Resistant
Protection	IP13

Size and Weight	
Width	250mm
Height	175mm
Depth	152mm
Weight	3.0kg



Dries Hands in 15 Seconds



Annual CO₂ Emissions



Saving Energy Reducing the Carbon Footprint



YEAR WARRANTY

ATC High Speed Cub Hand Dryer

Low energy, unique design



Key Features Include:

- 15 second drying time
- Low running costs
- Suitable for areas of low traffic
- Switchable heating output
- LED countdown indicator
- Available in brushed stainless steel / matt black / white
- Compact Design





Unique and sleek in design, this compact high speed hand dryer is best placed in areas of low footfall. The perfect fit across a range of industries.

Description

Product Code	Z-2651M	Z-2651BL	Z-2651WH
Cover Material	Stainless Steel	Stainless Steel	Stainless Steel
Finish	Brushed	Matt Black Painted	White Painted
Warranty	1 Year	1 Year	1 Year
Activation	Automatic	Automatic	Automatic

Electrical Specifications

Voltage	220/240V
Frequency (Hz)	50 / 60Hz
Motor Type	Brush Type
Power Output	1300 Watts
Motor Power	600 Watts
Heating Power	700W / Off
Amps	5.2 Amps
Sensor	0-250mm
Drying Time	15 seconds
Air Speed	65 m/s

Noise Level

72dB at 1m

Approvals



Safety Features

Motor Thermal Protection	Turns unit off at 100°C
Heater Thermal Protection	Turns unit off at 100°C
Time Protection	45s Auto Shut Off
Cover Screws	Vandal Resistant
Protection	IPX1

Size and Weight

Width	153mm
Height	280mm
Depth	162mm
Weight	3.2kg



Commercial



Hospitality



Sports & Leisure



Healthcare



Education



Annual CO₂
Emissions



Saving Energy
Reducing the
Carbon Footprint



YEAR
WARRANTY

ATC Panther ECO High Speed Hand Dryer

The preferred choice for high usage wash rooms



Key Features Include:

- 12-15 second drying time
- Low running costs
- Suitable for high traffic areas
- Switchable heat / speed setting
- Long life brush motor
- HEPA Filter (Optional)
- Vandal resistant
- Available in brushed stainless steel



With a 5 year warranty, this durable high speed hand dryer is effective – perfect for high traffic areas such as shopping centres, fast food restaurants or sports stadia. The optional HEPA filter captures 99.9% of bacteria.

Description

Product Code	PANZA06
Cover Material	Stainless Steel
Finish	Matt Stainless Steel
Warranty	5 Years
Activation	Automatic

Electrical Specifications

Voltage	220–240Vac
Frequency (Hz)	50 / 60Hz
Brush Motor with Dual Ball Bearings	12000-18000RPM (adjustable)
Power Output (adjustable)	1400 Watts
Motor Power (adjustable)	350W / 700 Watts
Heating Power (adjustable)	350W / 700 Watts
Sensor Range (automatically adjustable)	100–230mm
Drying Time	12–15 Seconds
Air Flow m/s	74-87m/s
Filter	Complete with filter

Noise Level

Maximum: 78dB at 1m

Approvals



Safety Features

Motor Thermal Protection	Auto Resetting turns off at 135°C
Heater Thermal Protection	Auto Resetting turns off at 85°C
Time Protection	60s Auto Shut Off
Cover Screws	Vandal Resistant
Protection	IPX1

Size and Weight

Width	205mm
Height	287mm
Depth	180mm
Weight	5.8kg



Commercial



Hospitality



Sports & Leisure



Healthcare



Education



Annual CO₂
Emissions



Saving Energy
Reducing the
Carbon Footprint



YEAR
WARRANTY

RETURN TO INDEX

ATC Premium Blade High Speed Hand Dryer

Elegant, hygienic and cost effective

Key Features Include:

- 10-15 second drying time
- Low running costs
- Suitable for areas of medium traffic
- Replaceable HEPA filter
- Anti-Bacterial UV Sterilisation
- Available in silver
- Long life brushless motor





Reach new hand drying heights with the leading ATC hand dryer – long life, sleek silver design with built-in anti-bacterial UV sterilisation and HEPA filter.

Description

Product Code	Premblade15
Finish	Silver
Warranty	3 Years
Activation	Automatic

Electrical Specifications

Voltage	220V - 240V
Frequency (Hz)	50 / 60Hz
Motor Type	Brushless Long life
Power Output (W)	2000 Watts
Motor Power (W)	700 Watts
Heating Power (W)	1300 Watts
Amps (A)	8.5 Amps
Sensor Adjustable	Fixed
Drying Time	10 – 15 seconds
Air Speed	90 – 95 m/s

Noise Level	70dB (at 1m)
--------------------	--------------

Filter	Replaceable HEPA Filter
---------------	-------------------------

Approvals	
------------------	--

Safety Features

Motor Thermal Protection	Turns unit off @ 95°C
Heater Thermal Protection	Turns unit off @ 100°C
Time Protection	25s
Cover Screws	Vandal Resistant
Protection	IP24

Dimensions and Weight

Width	300mm
Height	700mm
Depth	215mm
Weight	9.5kg



Commercial



Hospitality



Sports & Leisure



Healthcare



Education



35/100kg

Annual CO₂ Emissions



Saving Energy
Reducing the
Carbon Footprint



3
YEAR
WARRANTY

RETURN TO INDEX

ATC ECO Tap

Washroom Range

Wash & Dry
your hands
in 40
seconds!

Key Features Include:

- Taps installed in situ within sink, or above
- Hygienic, no-touch automatic operation
- Simple to use
- Energy saving, temperature control hand dryer
- Quiet operation
- Concealed mechanisms for easy maintenance



With a sleek, modern design the ECO Tap is designed to complement high traffic bathrooms as a complete set of soap dispenser, auto tap, and high speed hand dryer.

Product Codes:

Sink Mounted

ATC-ECOTAP-D
 ATC-ECOTAP-D-FAUCET
 ATC-ECOTAP-D-SOAP

Wall Mounted

ATC-ECOTAP-W
 ATC-ECOTAP-W-FAUCET
 ATC-ECOTAP-W-SOAP

Description

Cover Material	304 Stainless steel
Finish	Brushed
Activation	Automatic

Electrical Specifications Hand Dryer

Voltage	220 - 240Vac
Frequency (Hz)	50-60Hz
Motor speed	22000-29000RPM
Power Output	840-1000W
Motor Power	500W
Heating Power (off/min/max)	0/340-500W
Sensor Range	130mm ± 20mm (Auto Adjust)
Drying Time	12-15 Second

Wall / Sink

UK	CE	RoHS	WEEE
----	----	------	------

Approvals

Safety Features

Motor Thermal Protection	102°C Auto Resetting
Heater Thermal Protection	139°C Auto Resetting
Time Protection	60s Auto shut off
Cover	304 Stainless steel
Protection	I.P. 35

Dimensions

Sink mounted

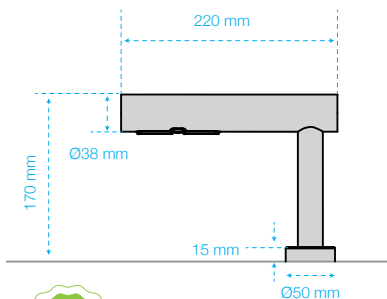

Wall mounted

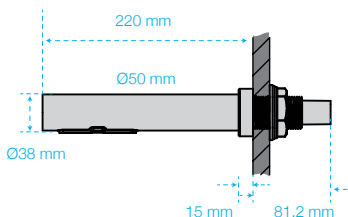

YEAR WARRANTY

ATC **Dahlia** Soap & Sanitiser Dispenser



Key Features Include:

- Automatic, no-touch operation
- Hygienic, prevents spread of harmful bacteria
- Battery Powered - 6x AAA batteries
- LED Low Battery Indicator
- Wall Mounted install in minutes
- Adjustable Floor Stand (optional)
- Adjustable Heights on portable stand 895mm-1700mm



The Dahlia Soap & Sanitiser Dispenser can be used either to dispense soap or sanitiser in a range of settings, such as commercial, hospitality, education, sports & leisure and healthcare.

Description

Product Code:	HANDSU
Box Quantity:	12 Pieces
Finish:	Brushed Stainless Steel
Activation:	Automatic
Floor Stand:	HS-FLOOR-STAND
Adjustable:	895mm – 1700mm

Adjustable Floor Stand – Optional

- Free Standing Station
- Battery Powered
- Sturdy yet Portable
- Adjustable Heights
- For use with Dahlia Soap & Sanitiser Dispenser
- Sold in pack of 2 units



Infrared Detection



Filling Dispenser



Commercial



Hospitality



Sports & Leisure



Healthcare



Residential



Education

Choose Hygiene. Choose HEPA.

What is 'HEPA'?

HEPA stands for 'High Efficiency Particle Arrestor', which works to trap tiny particles (up to 0.3 micrometers in diameter) found in the air.

Why they're great

ATC HEPA filters capture 99.9% of harmful particles, giving you a seamless, hygienic hand drying experience.

Maintenance

You change your coffee filter regularly, right? The same applies to HEPA filters. Make sure to change your HEPA filter every 6 months – those particles add up, and over time reduce the effectiveness of the filter.

A closer look

ATC HEPA filters are composed of thin fibres of glass and carbon-activated material. The result is a thick, paperlike material arranged in pleats. Particles passing through the air are trapped within this material.

Did you know?

The Panther HEPA filter comes complete with an anti-bacteria layer, and stylish stainless steel outer casing for a sleek finish.

Simply slide in or out for install and removal!



ATC HEPA filter, Tiger ECO



ATC HEPA filter, Panther ECO





Cost Savings

Energy Cost Comparison



Savings per year
€1,090.50
Based on 312 days
200 dries per day

Energy Cost Comparison

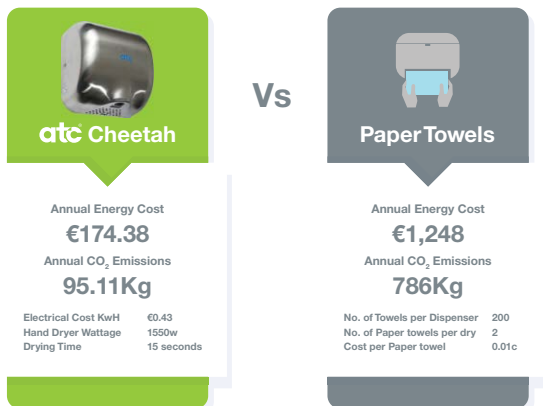

Savings per year
€1,073.62
Based on 312 days
200 dries per day

Figures correct as of November 2022

Energy Cost Comparison

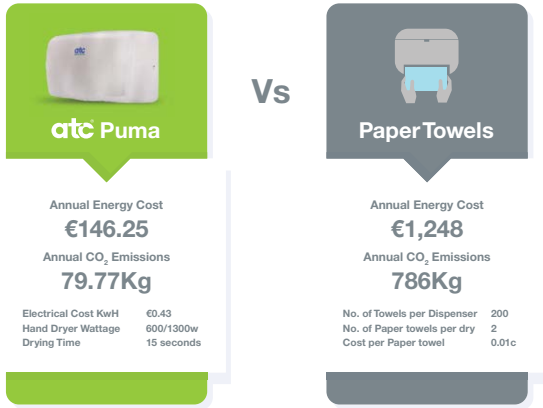

Savings per year
€1,101.75
 Based on 312 days
 200 dries per day

Energy Cost Comparison



Savings per year
€1,101.75
 Based on 312 days
 200 dries per day

Figures correct as of November 2022



Energy Cost Comparison

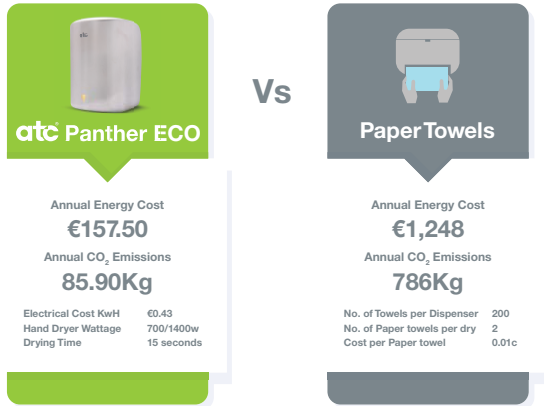

Savings per year
€1,090.50
Based on 312 days
200 dries per day

Energy Cost Comparison

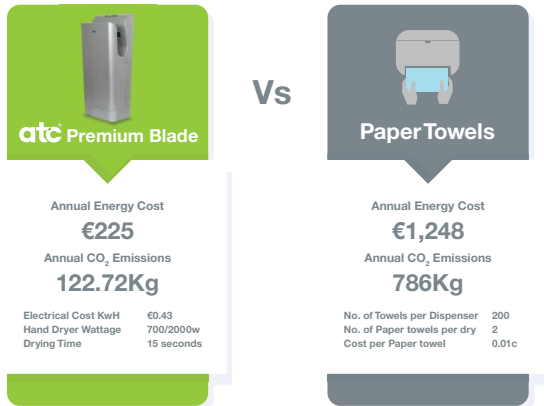

Savings per year
€1,023
Based on 312 days
200 dries per day

Figures correct as of November 2022

CO₂ Impact on the Environment

Carbon Emissions, otherwise known as greenhouse gas emissions, are the main contributors to climate change and global warming.

The concerning increases in the burning of fossil fuels directly correlates to the increase of carbon dioxide levels in the atmosphere and in turn the rapid increase of global warming.

Fossil Fuel Combustion

The largest source of carbon dioxide emissions is from the combustion of fossil fuels. This produces 87% of the human carbon dioxide emissions. Burning these fuels releases energy which is most commonly turned into electricity, heat or power for transportation. Some examples of where they are used are in industrial and commercial facilities such as Airports, Factories, Shopping Centre, Offices and smaller locations such as Gyms, Coffee Shops and Restaurants.

What Should Happen?

It is the responsibility of the Management in all commercial and industrial organisations to implement a plan to reduce their annual carbon emissions.



How can ATC Energy Efficient Hand Dryers Help?

ATC provide the widest and most complete range of Energy Efficient Hand Dryers on the market.

When you visit a wash room you want to dry your hands quickly and hygienically.

We provide all the options; from high usage locations such as Airports, Shopping Centres and Sports Stadia to medium usage in Offices, Hotels and Coffee Shops. Our hand dryers are low noise and provide a range of energy outputs that can be controlled by the facilities personnel.

On pages 33-35 we demonstrate the energy savings and CO₂ emissions of our hand dryers compared to using Conventional Hand Dryers or Paper Towels.

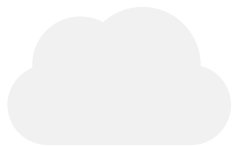

Conventional Hand Dryer

Paper Towel Dispenser

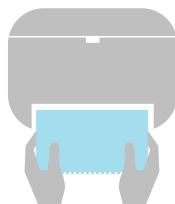

4.85g CO₂ per Dry

12.6g CO₂ per Dry

ATC Tiger ECO

ATC Premium Blade

ATC Cheetah



1.1g CO₂ per Dry

1.6g CO₂ per Dry

1.2g CO₂ per Dry

ATC Panther ECO

ATC Puma

ATC High Speed Cub



1.1g CO₂ per Dry

0.9g CO₂ per Dry

0.9g CO₂ per Dry



Thermal Electric Radiators & Panel Heaters

Thermal Electric Radiator Technology	40
Key Features of ATC Thermal Electric Radiators	44
ATC Smart Technology	45
Sizing Guide	46
The Smart RF Family	48
Sun Ray RF Thermal Electric Radiators	56
iLifestyle Thermal Electric Radiators	60
Merida RF Digital Panel Radiators	66
Neptune Low Level Radiators	68
Almeria ECO Digital Panel Heaters	70
Thermal Radiator Features	72

Eco-Friendly

Our thermal electric radiators use thermal emission oil for a quick and eco-friendly heat-up time. Built-in Open Window Technology prevents heat loss and saves energy.



EcoDesign
Lot 20 Compliant

Thermal Electric Radiator Technology

Electric Heating: How it Works

ATC's Thermal Electric Range use a combination of convection and radiated heat, to provide an evenly distributed, comfortable warmth to any room.

Where to Use

Electric radiators are ideal for heating domestic and commercial settings, providing comfortable and consistent heat for spacious rooms.

Integrated Technology

These radiators can be used as stand-alone heaters or part of a whole-house heating system, **with selected heaters** operated by an app.

What's Inside?

Thermal electric radiators are oil filled, encased in aluminium, and contain an electric element.



Did you Know?

There are 3 basic methods of heat transfer: Conduction, Convection, and Radiation. ATC's Electric Thermal Radiator Range uses:

Convection

The transfer of heat through the physical movement of air or fluid from one location to another.

And

Radiation

The transfer of heat by electromagnetic waves.



Thermal Radiator or Panel Heater?

What Are the Key Differences?



Thermal Electric Radiator

iLifestyle

- Robust, modern design
- Uses combined convection & radiant heating method
- Provides gradual warmth
- Lower running costs

Provides great levels of comfort & warmth in spaces that are used frequently.

Ideal for:



Kitchens



Living Rooms



Receptions



Offices



Panel Heater

Almeria ECO

- Lightweight, sleek design
- Uses convection heating method
- Provides immediate heat
- Low purchase cost

Effectively heats spaces that are used sparingly

Ideal for:



Bedrooms



Utility Rooms



Staircase Landings



Spare Rooms

Thermal Radiators & Panel Heaters

Complementing one another in the home

The Smart RF Residence

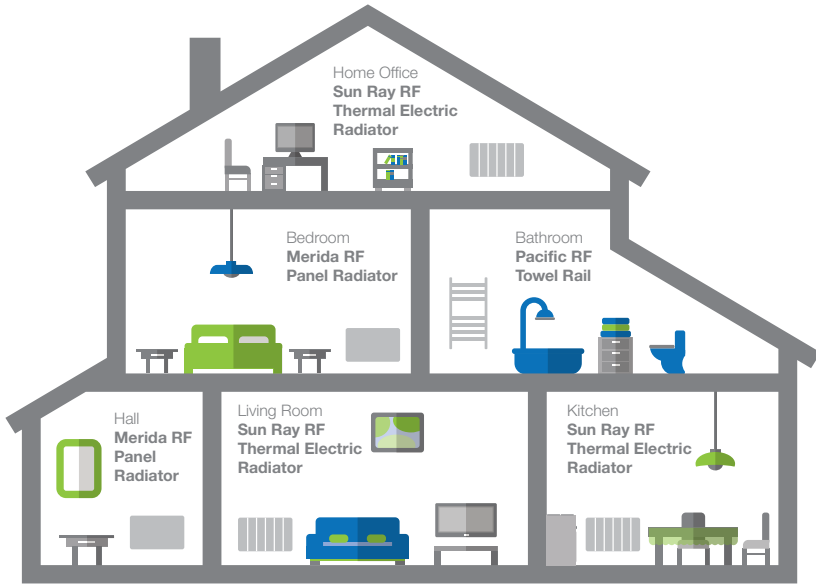

By using a combination of thermal electric radiators and panel heaters in settings such as the home, you avail of a comfortable, inviting warmth specifically tailored for each room.

ATC's range of Smart RF products allow for connectivity and controllability with the ability to control up to 30 heaters from your mobile phone.

Thermal Electric Radiators and Panel Radiators can also work in tandem in settings such as hotels, offices, apartment residences, schools & universities, sports & leisure facilities, and more.

Suitable for:



Commercial



Hospitality



Sports & Leisure



Healthcare



Residential



Education



Heat Distribution by Product Type

Results from the ATC test laboratory below demonstrate and compare the methods of heat distribution of different electric heaters.

ATC SunRay RF Thermal Radiator 750w

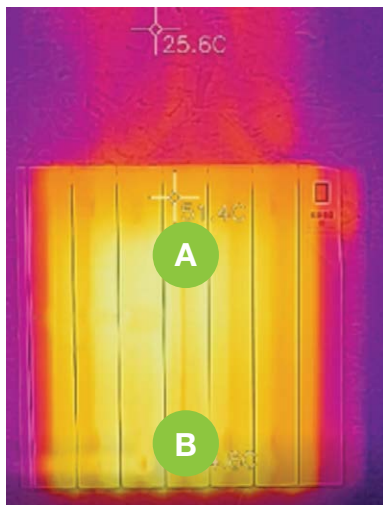

A Produces warm, controlled heat that reaches maximum temperature of 25.5 degrees.

B Heat is distributed evenly from heat source.

ATC Almeria-Eco Panel Heater 750w

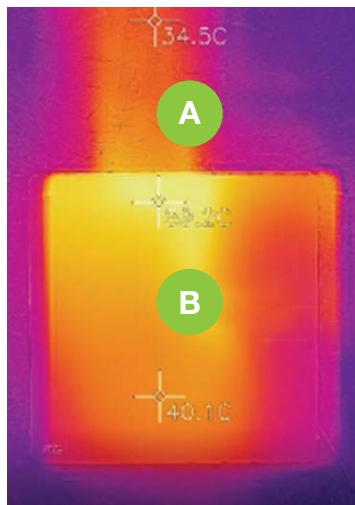

A Produces dry heat of up to 34 degrees; suitable for places that are used sparingly.

B Heat is unevenly distributed from heat source.

Key Features of ATC Thermal Electric Radiators

Smart Controllability to 0.2°C

PID controllers use a control loop feedback method to control the heating element and are the most accurate and stable type of control system, with temperature accuracy to 0.2°C.

The ATC apps allow online programming from anywhere in the world. The radiator can also be controlled directly via controls on the heater.

Controllability & Connectivity

ATC Thermal Electric Radiators offer a wide range of connectivity options. We offer a diverse selection of products with varying levels of controllability and connectivity options. Choose from direct control via the radiator's control screen right through to Smart Technology that can be connected and controlled on-the-go via your smart device.

Accessible Technology

- Easy to read, modern TFT Display
- Manual Boost allows quick operation outside of programmed times
- Triac thermostat ensures long life & silent control
- Audible feedback confirms buttons which have been activated

Warranty Information



iLifestyle

Sun Ray RF & Neptune



ATC Smart Technology

Connectivity:

The Power of RF Radio Frequency Technology

Radio Frequency (RF) products communicate using a smart and robust RF Mesh gateway which allows for a more reliable and longer-reaching communication path between the heaters and the gateway.

The Power of Wifi Direct Technology

Our Wi-Fi Direct products operate directly between each heater and the Wi-Fi router, ideal for single heaters with no need for a gateway

Easy to Program & Install

Ease of set-up is a key point in the design of the ATC Smart Family of products.

Simple and robust mounting hardware with secure locking brackets ensure that these products sit perfectly and safely within the spaces they provide warmth.

The set-up and programming of both Wi-Fi Direct and RF-wireless systems is simple and intuitive, requiring minimal effort.

Easy to transport and easy to install.

Control at your Fingertips

Gain complete control over your heating systems through our ATC Smart Apps: Tevolve (RF) and ATC Cala (Wi-Fi Direct).

- TRIAC electronic thermostat – accurate to 0.2°C
- PID Intelligent Control
- Open Window Feature
- Adaptive Start
- Frost Protection for holiday homes



ATC Tevolve App –
RF Products



ATC Cala App –
Wi-Fi Direct Products



Electric Heating Sizing Guide

Floor Area (Standard 2.4M / 8Ft Ceiling Height.) M ² Square Ft		Insulation Level		
		Poor	Normal	Excellent
Up to 3M ²	Up to 32Sq Ft	540W	300W	240W
Up to 6M ²	Up to 65Sq Ft	1080W	600W	480W
Up to 9M ²	Up to 97Sq Ft	1620W	900W	720W
Up to 12M ²	Up to 129Sq Ft	2160W	1200W	960W
Up to 15M ²	Up to 161Sq Ft	2700W	1500W	1200W
Up to 18M ²	Up to 194Sq Ft	3240W	1800W	1440W
Up to 21M ²	Up to 226Sq Ft	3780W	2100W	1680W
Up to 24M ²	Up to 258Sq Ft	4320W	2400W	1920W
Up to 27M ²	Up to 291Sq Ft	4860W	2700W	2160W
Up to 30M ²	Up to 323Sq Ft	5400W	3000W	2400W

Follow us on Social Media

@ATC_Electrical



The Smart RF Family

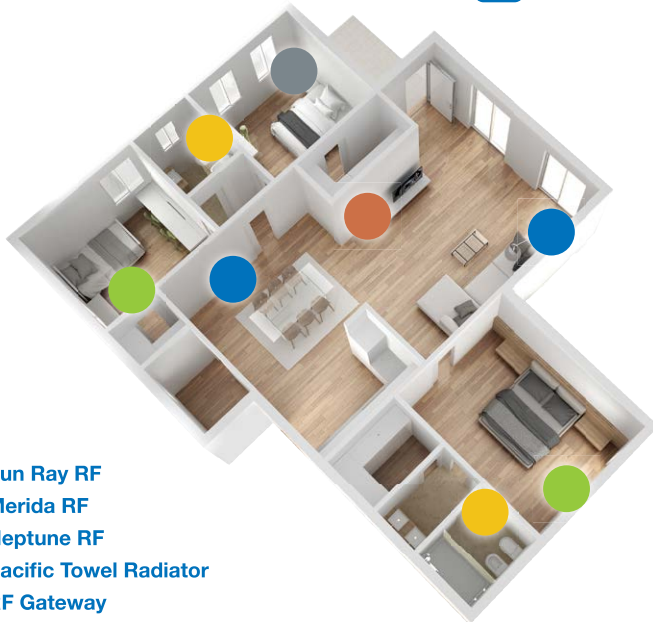

We design with you in mind.

Hey **Alexa**, turn on my kitchen heating.

Hey **Google**, turn on my kitchen heating.

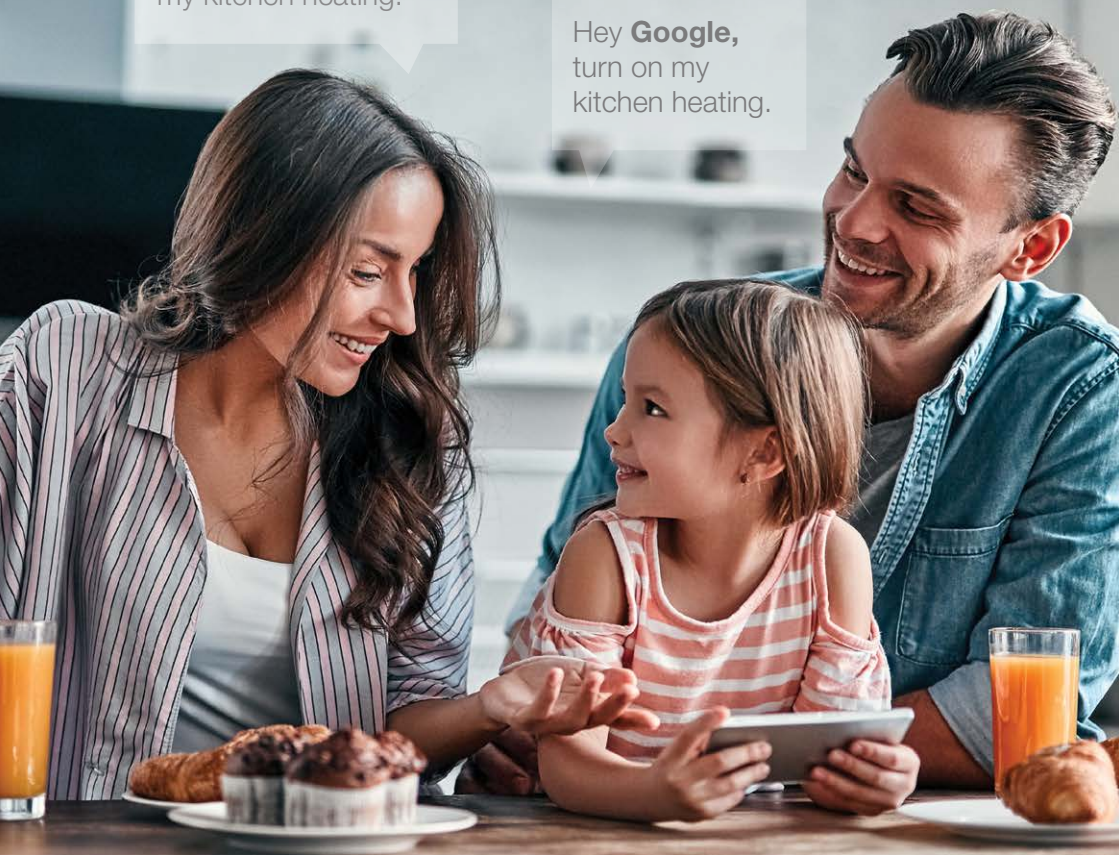

Our connected products work with both Amazon & Google devices.



Google Assistant

[RETURN TO INDEX](#)

Explore the **ATC Smart Range**



Sun Ray RF

Thermal Electric Radiator



iLifestyle

Thermal Electric Radiator



Pacific RF
Heated Towel Radiator



Merida RF
Digital Panel Radiator

Manual Control on the Radiator

All radiators are equipped with a large TFT screen.



Merida

Digital Panel Radiator



Pacific RF

Heated Towel Radiator



Take Control using our App



Apartments

Change settings remotely



Hotels & Hostels

Controllability from reception



Download

for FREE on your mobile, tablet or computer device



- Programmable 24/7 from anywhere in the world
- 3 program modes: **Comfort**, **Eco** & **Frost Protection**
- Can control up to 30 radiators
- Each radiator can be named
- Voice Control
- Monitor whole house energy usage with RF monitor



Offices

Smart design



Holiday Homes

Frost protection for piece of mind

Voice Control

 amazon alexa

 Google Assistant



Monitor your Electricity Consumption

Purchase the Sun Ray RF with a Power Monitor to gain insight into your total electricity consumption in your home, office, hotel, etc. The Power Monitor measures electrical current, providing an hourly reading of your electricity consumption.

Couple this with the insights available thanks to the RF app on your radiator energy usage, and you'll be on your way to honing your electricity usage and reducing your energy bills.

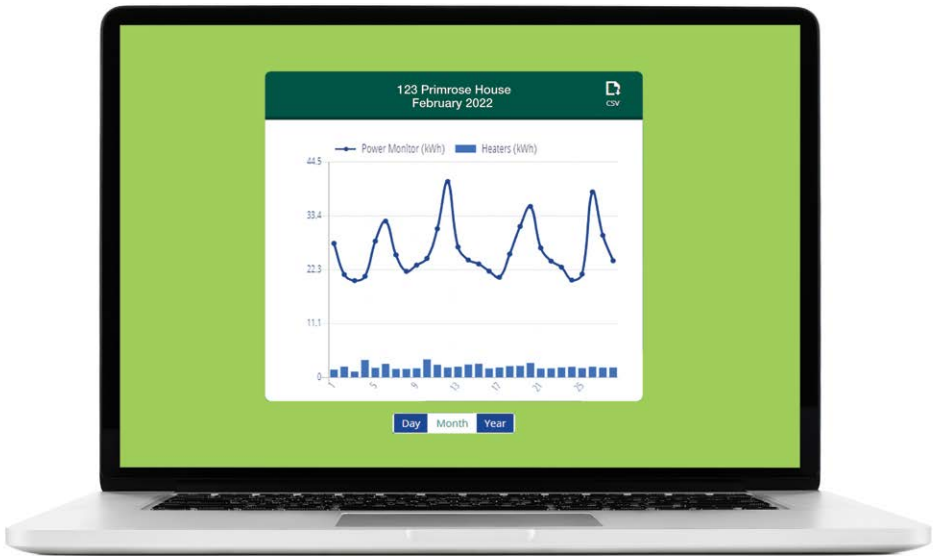

Power Monitor sold separately: Product CodeRF-Monitor



[RETURN TO INDEX](#)

ATC Sun Ray RF Electric Thermal Radiators

Experience Unique

Key Features Include:

- Wireless control via Gateway and App
- Voice control compatibility with Amazon Alexa and Google Assistant
- Silent electronic thermostat – accurate to 0.2°C
- PID Intelligent Control
- Open Window Feature
- Adaptive Start
- Digital Program control
- Landlord Mode for control in hotels, student accommodation etc.
- Stand-alone control on radiator
- Frost Protection
- Pin code lock

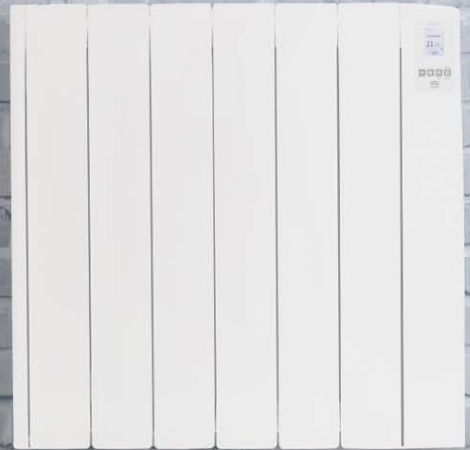



The Sun Ray RF is an oil-filled thermal electric radiator which incorporates unique advanced technology and controllability in one radiator, leading the way in sustainable living.

Technical Details

Product Code	RF350	RF500	RF750	RF1000
Number of Fins	3	4	6	8
Power W	350	500	750	1000
Insulation Class	Class 1	Class 1	Class 1	Class 1
IP Protection	IP20	IP20	IP20	IP20
Voltage (AC)	230	230	230	230
Dimensions (H x W x D) mm	580 x 340 x 100	580 x 420 x 100	580 x 580 x 100	580 x 740 x 100
Approvals	UKCA, CE, Rohs	UKCA, CE, Rohs	UKCA, CE, Rohs	UKCA, CE, Rohs
Weight (kg)	6.9	8.8	12.5	16.4

Technical Details *continued*

Product Code	RF1250	RF1500	RF1800
Number of Fins	10	12	12
Power W	1250	1500	1800
Insulation Class	Class 1	Class 1	Class 1
IP Protection	IP20	IP20	IP20
Voltage (AC)	230	230	230
Dimensions (H x W x D) mm	580 x 900 x 100	580 x 1060 x 100	580 x 1060 x 100
Approvals	UKCA, CE, Rohs	UKCA, CE, Rohs	UKCA, CE, Rohs
Weight (kg)	20	23.9	23.9

RAL Colour: RAL9016

Popular Applications of the Sun Ray RF:



Commercial



Hospitality



Residential



Sports & Leisure



Education



Healthcare





[RETURN TO INDEX](#)



RF Gateway



On-the-go control via the ATC Evolve App



Saving Energy
Reducing the
Carbon Footprint



EcoDesign
Lot 20 Compliant



Introducing the iLifestyle

The award-winning Lifestyle radiator is now a Wi-Fi connected radiator!



Key Features Include:

- Smart controllability
- Digital connected heating solution
- Subtle design for any room
- Provides efficiency and comfort
- Maintenance free



The award-winning Lifestyle radiator is now a Wi-Fi connected radiator, offering smart controllability, efficient heating and maximum comfort. A maintenance free option once installed.

Technical Details

Product Code	WLS500	WLS750	WLS1000	WLS1200
Number of Fins	3	5	6	7
Power W	500	750	1000	1200
Insulation Class	Class 1	Class 1	Class 1	Class 1
IP Protection	IP24	IP24	IP24	IP24
Voltage (AC)	230	230	230	230
Dimensions (H x W x D) mm	581 x 396 x 98	581 x 556 x 98	581 x 636 x 98	581 x 716 x 98
Approvals	UKCA, CE	UKCA, CE	UKCA, CE	UKCA, CE
Weight (kg)	6.4	9.2	10.7	12

Technical Details continued

Product Code	WLS1500	WLS1800
Number of Fins	9	11
Power W	1500	1800
Insulation Class	Class 1	Class 1
IP Protection	IP24	IP24
Voltage (AC)	230	230
Dimensions (H x W x D) mm	581 x 876 x 98	581 x 1036 x 98
Approvals	UKCA, CE	UKCA, CE
Weight (kg)	14.8	17.7

RAL Colour: RAL9010

Popular Applications of the iLifestyle:



Commercial



Hospitality



Sports & Leisure



Healthcare



Residential



Education



EcoDesign
Lot 20 Compliant



Energy Cost Comparison iLifestyle vs Storage Heaters

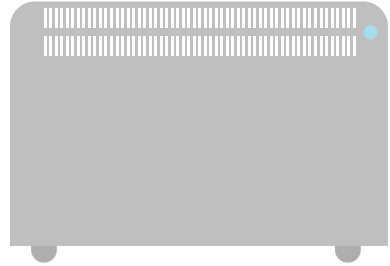

iLifestyle

Area 18m ²	1800w
Kw cost per hour ¹	€0.43
Total consumption per day	€3.12
Total Cost Per Month	€93.46

Storage Heater

Area 18m ²	3300w
Kw cost per hour ¹	€0.23
Total consumption per day	€5.27
Total Cost Per Month	€158

Assumptions: The above figures are based on a 7 hour heating cycle using electricity on the night rate for the high heat retention storage heater. The thermal radiator is on at full capacity when heating, approx 50% capacity when at temperature, for 6 hours per day (2 in the morning and 4 in the evening on a standard day rate tariff.) Both heaters are worked on a 30 day month.

The calculation does not take into account the need for boost heating for the storage heaters in the evening.



Lower Bills
€93.46
Lower Energy Consumption



Higher Bills
€158
Higher Energy Consumption



¹ Day (€0.4623) Night rate (€0.228) on the Electric Ireland Nightsaver plan. Standing charge not included.

Controllability
whenever
wherever



 works with the
Google Assistant

 amazon alexa

 2.4 GHz Wireless
Communications

 iLifestyle

Estimate your Heating Consumption Costs

Step 1. Set up & customise based on the electricity unit rate (Kwh) from your energy supplier. Track by individual heater, entire home / premises, or zone within your home / premises.

Step 2. Use your heaters as normal.

Step 3. Track the estimated consumption as recorded by the iLifestyle app or directly by individual heater

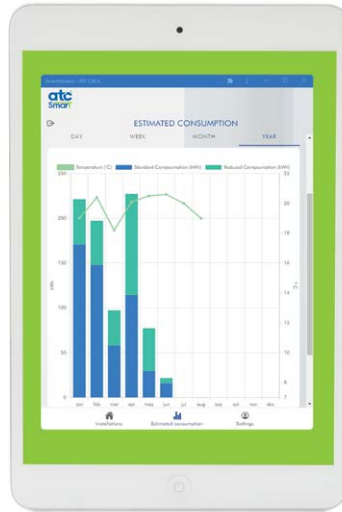
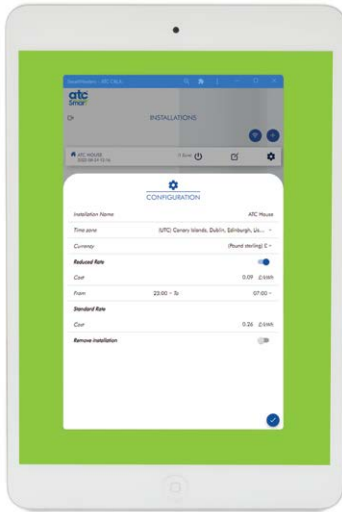



[RETURN TO INDEX](#)

ATC Merida RF

Digital Panel Radiators

Experience Unique



Key Features Include:

- On-the-go controllability via App & RF Gateway
- Use less energy and save money with PID Intelligent Control
- Conserve energy with Open Window Technology
- Customised heating schedule with Adaptive Start Feature
- Triac Electronic Thermostat ensures silent operation
- Low surface temperature option
- Pin code lock



Part of the ATC Smart family of heaters, the Merida RF incorporates advanced technology to ensure energy efficiency. Install with the Sun Ray radiator and Pacific RF Heated Towel Rail for a sublime heating experience.

Technical Details

Product Code	MER500	MER750	MER1000	MER1500	MER2000
Power (W)	500	750	1000	1500	2000
Insulation Class	Class I	Class I	Class I	Class I	Class I
IP Protection	20	20	20	20	20
Voltage (AC)	230	230	230	230	230
Dimensions (HxWxD) mm	443 x 540 x 125	443 x 540 x 125	443 x 625 x 125	443 x 810 x 125	443 x 1000 x 125
Approvals	UKCA, CE, RoHs	UKCA, CE, RoHs	UKCA, CE, RoHs	UKCA, CE, RoHs	UKCA, CE, RoHs
Weight (Kg)	5.7	5.7	6.2	7.9	9

Popular Applications of the Merida RF:



Commercial



Hospitality



Sports & Leisure



Healthcare



Residential



Education



Intuitive Display Screen



On-the-go control via the ATC Tevolve App



RF Gateway



EcoDesign
Lot 20 Compliant



ATC Neptune Electric Thermal Radiators

Simple to fit, operate & program!

Control multiple Neptune units with the *Remote Control

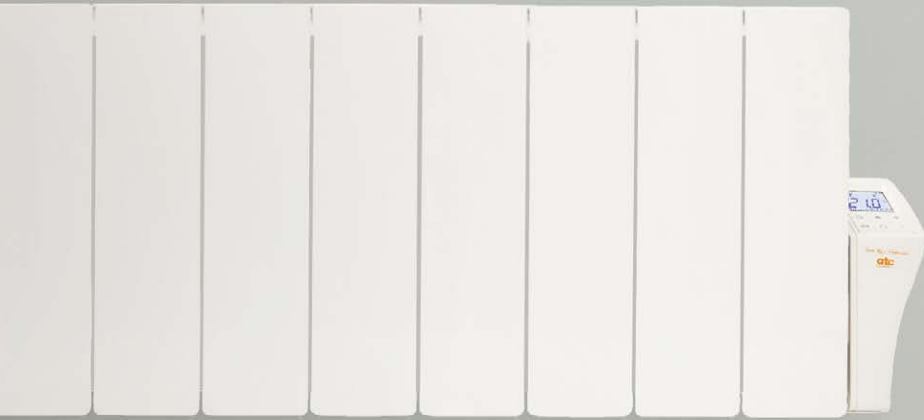

Key Features Include:

- 3 Operating Modes: Eco, Comfort & Frost Protection
- Filled with high quality thermic emission oil for quick heat-up time

Improved Energy Efficiency:

- Adaptive Start Technology
- PID Intelligent Control
- Open Window Technology



The ATC Neptune Electric Thermal Radiator is a high quality, low level aluminium radiator designed for heating areas with low level walls or areas where space is restricted.

Technical Details

Product Code	LR950	LR1425
Number of Fins	10	15
Power W	950	1425
Insulation Class	Class 11	Class 11
IP Protection	IP24	IP24
Voltage (AC)	230	230
Dimensions (H x W x D) mm	340 x 865 x 96	340 x 1265 x 96
Approvals	UKCA, CE, RoHs	UKCA, CE, RoHs
Weight (kg)	12.8	19.2

RAL Colour: RAL9016

*Optional Infra Red Remote

Product Code	LR-REMOTE
Product Description	Remote Control for Low Level Electric Radiator

Popular Applications of the Neptune:



Commercial



Hospitality



Residential



Sports & Leisure



Education



Healthcare



EcoDesign
Lot 20 Compliant

UK
CA



ATC Almeria Eco Digital Panel Heater

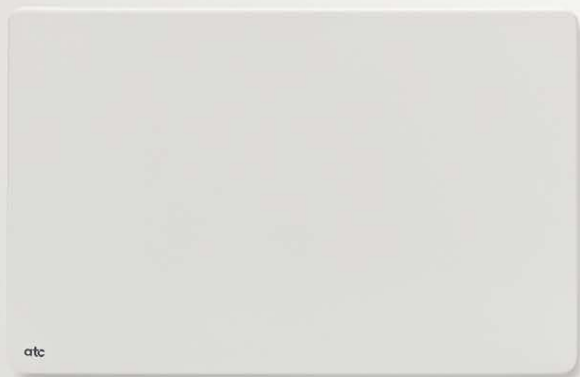

Key Features Include:

- Simple to install, program and operate
- Large, easy-to-read TFT LCD display screen
- 3 Operating Modes: Program, Manual, Landlord Mode
- 2 user adjustable temperature settings – Comfort & Economy
- Dedicated boost facility with program advance mode
- Conserve energy with Open Window Technology
- Lockable Keypad



Install and program this energy efficient digital panel heater with ease. Its sleek design makes it perfect for use in a wide variety of settings.

Technical Details

Product Code	DPH500-ECO	DPH750-ECO	DPH1000-ECO	DPH1500-ECO	DPH2000-ECO
Power (W)	500	750	1000	1500	2000
Voltage (V)	220-240	220-240	220-240	220-240	220-240
Frequency (Hz)	50	50	50	50	50
Thermostat	Electronically Adjustable between 5° and 30°				
Safety Cut-Out (°C)	120°	120°	120°	110°	120°
Width (mm)	440	440	520	680	840
Depth (mm)	105	105	105	105	105
Height (mm)	440	440	440	440	440
Depth with Bracket (mm)	110	110	110	110	110
Weight (Kg)	4.3	4.3	4.5	5.5	6.5
IP Protection	24	24	24	24	24
Colour	White				
Approvals	CE, Intertek Gs, RoHS, ErP				
Eco-Design Lot 20	Yes				

Popular Applications of the Almeria Eco:



Commercial



Hospitality



Residential



Sports & Leisure



Education



Healthcare



EcoDesign
Lot 20 Compliant



Thermal Radiator Features

Energy Efficiency

iLifestyle
PROFESSIONAL

Sun Ray RF
CONNECTED

Open Window Technology for energy savings	✓	✓
PID Intelligent Control accurate to 0.2°C	✓	✓
Triac Switching for long life and silent control	✓	✓
Adaptive Start function for energy savings	✓	✓
Ecologically friendly mineral heat transfer fluid	✓	✓

Controllability

Voice Control via Amazon Alexa and Google Home	✓	✓
Remote control through App	✓	✓
Direct control via TFT screen	✓	✓

Key Features

Landlord Mode for greater control	—	✓
Password protected controls	—	✓
Lockable controls	✓	✓
Manual Boost	✓	✓

Data Sources

LOT 20 Eco Design Compliant programmable controls	✓	✓
Built-in consumption meter	✓	✓
Built-in fault detection	✓	✓



Sun Ray RF
CONNECTED



iLifestyle
PROFESSIONAL



Electric Heating Products

What is Radiant Heating?	76
Underfloor Heating	78
Heatstat Room Thermostat	80
Nexum RF Connected Thermostat	82
Pacific Towel Radiators	84
Bavaro Downflow Heater	90
Mirror Defog Heaters	92
Bathroom Range	94
Welcome Overdoor Heater	96
Radiant Ceiling Heaters	100
Hot Top Infrared Heater	102

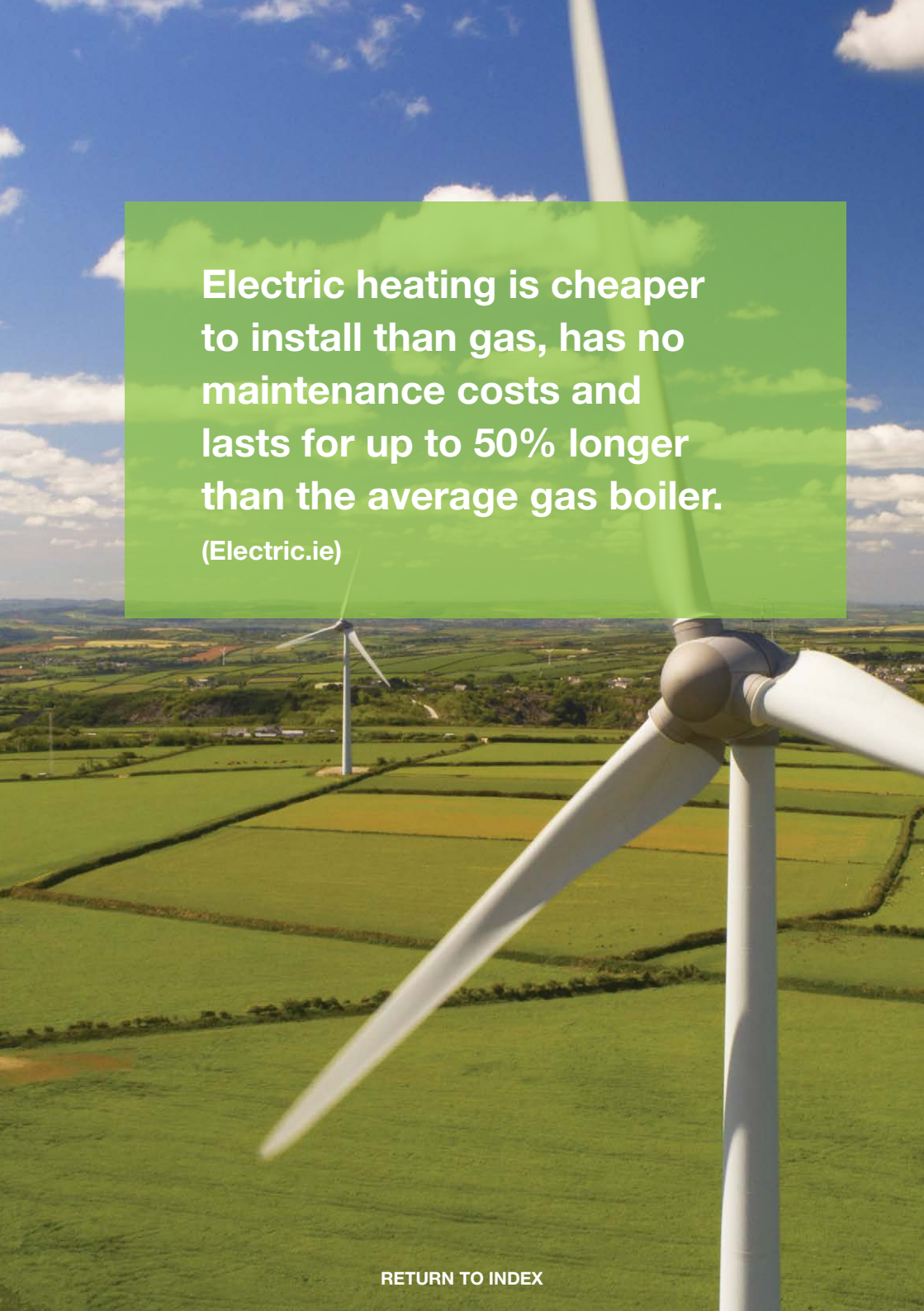
An aerial photograph of a wind farm in a lush green landscape. The foreground shows a close-up of a white wind turbine's nacelle and blades. In the distance, another turbine stands in a field of rolling green hills under a blue sky with scattered white clouds. A semi-transparent green rectangular box is overlaid on the upper portion of the image, containing white text.

Electric heating is cheaper to install than gas, has no maintenance costs and lasts for up to 50% longer than the average gas boiler.

(Electric.ie)

What is Radiant Heating

Radiation is a method of heat transfer used in many electrical heating products.

How it Works

These products emit **electrical energy** in a way that heats objects and surfaces without affecting the air in between.

Radiant heating does not heat spaces, but rather its energy **heats up people and objects directly.**

Did you Know?

When you're enjoying the feeling of warmth on your skin when sunbathing, this is heat radiation in action!

Think about it – the sun's heat energy directly heats your body, but doesn't heat the air. That's why a cool breeze can feel most welcome on a hot day!



Next Day Delivery Across Ireland*



353 (1) 467 8301 | sales@atc.ie | [atc.ie](https://www.atc.ie)

*For orders placed by 2.30pm

[RETURN TO INDEX](#)



ATC Electric Underfloor Heating

It's like Walking on Sunshine

Key Features Include:

- Luxurious comfort
- Single end connection for easy install
- Can be controlled by ATC HS500 Digital Thermostat or the Nexum RF Thermostat
- Maintenance free
- Minimises dust & air movement



Experience Luxurious comfort – electric under floor heating is an efficient and economical addition or alternative to standard heating systems. Suited to residential and hospitality settings such as bathrooms and kitchens.

For Tiled Floors Only

The ATC range of electric underfloor heating mats should be installed by an electrician or installer who has knowledge of underfloor heating installations. The heating mats can only be installed under tiles. It is recommended that the mat is laid on an insulation board such as the F-Board. This will speed up heating time and also ensure that 97% of the heat output is upwards. Heating mats are primarily used for direct heat installations.

Product Features

- Heating load is 160w/m²
- Mat sizes from 0.5M² through to 16.3M²
- Mats can be joined together at the thermostat
- Optional Digital thermostat available for simple and accurate control
- Minimises dust and air movement
- Must be installed on F-Board insulation board for most efficient heat output

Warranty

- 10 year Warranty on cable mats*

* With return of completed warranty document or else 12 month warranty.



Hospitality



Residential



Table of Heating Mat Sizes

Code	Output	Width	Area
160W/M ²	W	M	M ²
LDTS 160/ 0.5	80	0.5	0.5
LDTS 160/ 1	160	0.5	1.0
LDTS 160/ 1.5	240	0.5	1.5
LDTS 160/ 2	320	0.5	2.0
LDTS 160/ 2.5	400	0.5	2.5
LDTS 160/ 3	480	0.5	3.0
LDTS 160/ 3.5	560	0.5	3.5
LDTS 160/ 4	640	0.5	4.0
LDTS 160/ 5	800	0.5	5.0
LDTS 160/ 6	960	0.5	6.0
LDTS160/ 7	1120	0.5	7.0
LDTS160/ 8	1280	0.5	8.0
LDTS160/ 10	1600	0.5	10.0
LDTS160/ 11	1760	0.5	11.0
LDTS160/ 12	1920	0.5	12.0
LDTS160/ 13.3	2150	0.5	13.3
LDTS160/ 16.3	2600	0.5	16.3

Technical Details

Model ATC Ecofloor Underfloor Heating

Product Code LDTS160/XX

Heat Cable Colour Orange

Connection Cable Colour Black

Electrical Specifications

Voltage (Volts) 230-240 Vac 1Ø

Frequency (Hertz) 50

Power (Watts) 160w/M²

Product Specifications

Mat Width (M) 0.5

Heating type Direct

Complete with floor probe No

Connection Cable length (M) 3

ATC HeatStat

Digital Thermostat



Key Features Include:

- Touch sensitive controls
- Large easy to read LCD screen
- Automatic timer with boost mode
- Dedicated manual mode
- Switches 16A resistive load
- Comes with floor probe
- Childlock feature





The HeatStat Digital Thermostat is a multi-function digital thermostat that is easy to program and control all electric heating products, including electric underfloor heating. The large, easy to read LCD screen is controlled by touch sensitive buttons allowing many control options.

Technical Details

Model	HeatStat Room thermostat
Product Code	HS500
Colour	White

Electrical Specifications

Voltage (Volts)	220-240 Vac
Frequency (Hertz)	50-60
Switching Capacity (Amps)	16A Resistive, 1A Inductive
Control	Touch sensitive buttons
Double Insulated	Yes



Underfloor Heating

Supplied with Floor probe for Electric Under Floor heating control

Program Specifications

Program Type	4 On / Off per day
Program Days	5 & 2, 6 & 1, 7, Off
Control Type	Floor / Room / Floor & Room
Open Window Control	Yes
Manual Mode	Yes
Holiday Mode	Yes
Childlock Mode	Yes
Automatic Timer with Boost Mode	Yes
Temperature Range (Adjustment)	5° to 35°C



Mounting and Installation

Installation	Wall Mounted
Dimensions (HxWx D) mm	86 x 86 x 16
IP Rating	20



EcoDesign
Lot 20 Compliant



ATC Nexum RF Connected Thermostat



Key Features Include:

- Thermostat Function to control indoor temperature
- Compatible with most electrical underfloor heating brands and floor sensors
- Compatible with immersion heaters, outdoor heating and panel heaters
- Flexible programming – 30 or 60 minute intervals
- Pin code key lock



The Nexum is an RF connected digital thermostat which offers full controllability of any electric heating product, from underfloor heating to water heaters to panel heaters. Perfect for both commercial and domestic applications.

Technical Details

Model	ATC Nexum RF connected thermostat
Product Code	RF-STAT
Colour	White

Electrical Specifications

Voltage (Volts)	220-240 Vac
Frequency (Hertz)	50-60
Switching Capacity (Amps)	16 (Resistive) 1 (Inductive)
Power (Watts)	3600 Max
Control	Touch sensitive buttons
Insulation Class	CL.II
Communication	Yes, RF Gateway required

Program Specifications

Program Type	up to 48 On off per day (30 min Blocks)
Program Days	5 & 2, 6 & 1, 7, Off
Control Type	Room, Room and Floor, Floor only
Timer mode	Yes - No Temperature Control on / off only
Open Window Control	Yes
Adaptive start	Yes
Boost	Yes
Manual Mode	Yes
Holiday mode	Yes
Runback / Landlord mode	Yes
°C or °F	Yes
Controls lock	Yes , with or without pin code
Works With Amazon Alexa	Yes (When connected to RF Gateway)
Works With Google assistant	Yes (When connected to RF Gateway)
Works with other floor probes (NTC@25°C)	Yes, 6.8kΩ, 10kΩ, 12kΩ, 15kΩ, 33kΩ, 47kΩ
Comes Complete with floor probe	Yes

Mounting and Installation

Installation	Wall mounted, 35mm recessed or Surface box required
Dimensions (HxWxD) mm	86 x 86 x 16
IP Rating	20



EcoDesign
Lot 20 Compliant



Saving Energy
Reducing the
Carbon Footprint



1
YEAR
WARRANTY

RETURN TO INDEX

ATC **Pacific** Heated Towel Radiators

Ideal for bathrooms and kitchens



Key Features Include:

- Quick and easy to install
- Fitted with pre-wired electric element
- 100% leak tested
- 2 Year long life warranty



ATC Pacific Heated Towel Radiators are modern in design and aesthetically pleasing to the eye. Manufactured with carbon steel ensuring product longevity and high quality.

Technical Details

Model	ATC Pacific Heated Towel Radiators			
Product Code	TRC800-500ELE300	TRC1100-500ELE300	TRW800-500-ELE300	TRC800-500-MEG300
Colour	Chrome	Chrome	White	Chrome

Electrical Specifications

Voltage (Volts)	230-240 Vac 1Ø	230-240 Vac 1Ø	230-240 Vac 1Ø	230-240 Vac 1Ø
Frequency (Hertz)	50	50	50	50
Power (Watts)	300	300	300	300
Running Current (Amps)	1.3	1.3	1.3	1.3
Insulation Class	CL.I	CL.I	CL.I	CL.I
Cable Entry	Left	Left	Left	Left

Product Specifications

Thermostat type	Fixed	Fixed	Fixed	Adjustable
Temperature setting	70°C	70°C	70°C	30°C-60°C in 5 steps
Thermal Fuse	110°C	110°C	110°C	Electronically limited

Mounting & Installation

Installation	Wall mounted	Wall mounted	Wall mounted	Wall mounted
Dimensions (HxWxD) mm	800 x 500 x 110	1100 x 500 x 110	800 x 500 x 110	800 x 500 x 110
Weight (Kg)	8.9	11.7	8.9	8.9
IP Rating	X5	X5	X5	X4



Hospitality



Residential



2
YEAR
WARRANTY

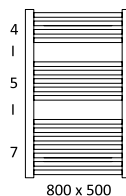

800 x 500

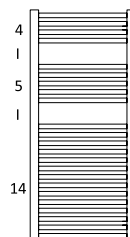

1100 x 500

ATC Pacific RF Towel Radiator

Smart Heating, Simple Controllability



Key Features Include

- On-the-go controllability via App and RF Gateway
- Simple to install, program and operate
- Large, easy to read TFT LCD display
- 4 Operating Modes: Eco, Comfort, Frost Protection, Landlord Mode
- PID Intelligent Control
- Open Window Technology
- Adaptive Start Feature
- Available in white, black or chrome



Part of the ATC Smart Range of products, the Pacific RF Towel Radiator provides smart connected heating, and has been designed to be used in conjunction with the Sun Ray RF and Merida RF heaters.

Technical Details

Model	ATC Pacific RF Towel Radiator		
Product Code	RFTR780WH	RFTR780BL	RFTR780CR
Colour	White	Black	Chrome
Height (mm)	780	780	780

Electrical Specifications

Voltage (Volts)	230-240 Vac 1Ø	230-240 Vac 1Ø	230-240 Vac 1Ø
Frequency (Hertz)	50	50	50
Power (Watts)	300	300	300
Running Current (Amps)	1.3	1.3	1.3
Insulation Class	CL.II	CL.II	CL.II
Cable Entry	Right	Right	Right

Mounting & Installation

Installation	Wall mounted	Wall mounted	Wall mounted
Dimensions (HxWxD) mm	780 x 500 x 120	780 x 500 x 120	780 x 500 x 120
Height including controls (mm)	860	860	860
Weight (Kg)	9	9	9
IP Rating	44	44	44

Technical Details *continued*

Model	ATC Pacific RF Towel Radiator		
Product Code	RFTR920WH	RFTR920BL	RFTR920CR
Colour	White	Black	Chrome
Height (mm)	920	920	920

Electrical Specifications

Voltage (Volts)	230-240 Vac 1Ø	230-240 Vac 1Ø	230-240 Vac 1Ø
Frequency (Hertz)	50	50	50
Power (Watts)	450	450	450
Running Current (Amps)	2.0	2.0	2.0
Insulation Class	CL.II	CL.II	CL.II
Cable Entry	Right	Right	Right

Mounting & Installation

Installation	Wall mounted	Wall mounted	Wall mounted
Dimensions (HxWxD) mm	920 x 500 x 120	920 x 500 x 120	920 x 500 x 120
Height including controls (mm)	1000	1000	1000
Weight (Kg)	11	11	11
IP Rating	44	44	44

Continued on the next page

Technical Details *continued*

Program Specification (For all models)

Program Type	up to 48 On off per day (30min Blocks)
Program Days	5 & 2, 6 & 1, 7, Off
Open window control	Yes
Adaptive Start	Yes
Boost	Yes
Manual Mode	Yes
Holiday mode	Yes
Runback / Landlord mode	Yes
°C or °F	Yes
Controls lock	Yes , with or without pin code
Works With Amazon Alexa	Yes (When connected to RF Gateway)
Works With Google assistant	Yes (When connected to RF Gateway)



Hospitality



Residential



EcoDesign
Lot 20 Compliant



The Smart RF Family

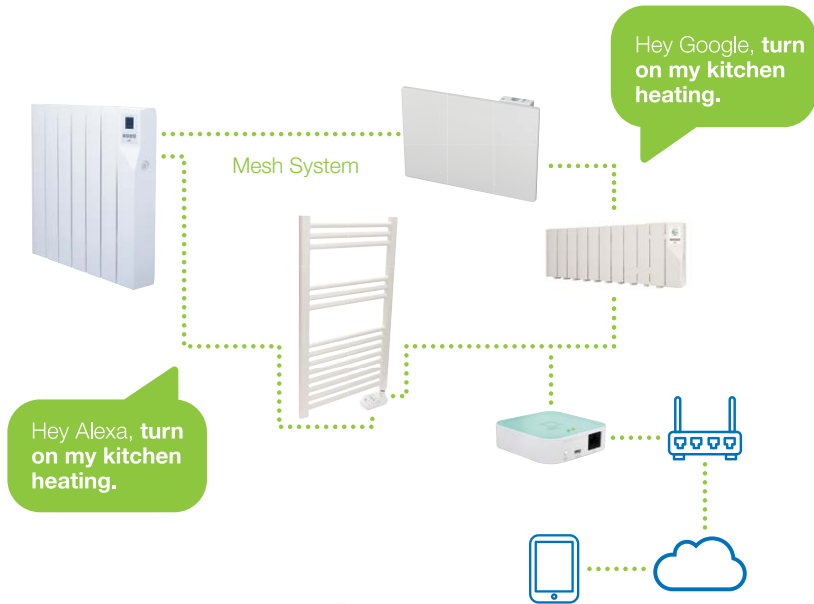

ATC Bavaro Bathroom Downflow Heater



Key Features Include:

- Easy to install
- Wall mounted
- Two power settings: 1kW & 2kW
- Pull cord operation
- Three colour neon indicator
- Electronic thermostat
- Dual safety cutouts with self resetting high level thermostat & thermal fuse



Sleek pullcord design producing a warm downflow of air to warm cold bathroom settings. Wall mounted and easy to install.

Technical Details

Model	ATC Bavaro Downflow Heater
Product Code	DF2000
Colour	White

Electrical Specifications

Voltage (Volts)	230-240 Vac 1Ø
Frequency (Hertz)	50
Power (Watts)	0 / 1000 / 2000
Running Current (Amps)	0 / 4.3 / 8.7
Insulation Class	CL.II

Product Specifications

Control	Pullcord
Timer	Yes - 30 minute countdown timer
Thermostat	Fixed. 30°C at 1kW setting, 45°C at 2kW setting
Safety Cut-out	2, Self resetting thermal cut-out and Thermal Fuse

Mounting & Installation

Installation	Wall mounted only
Dimensions (HxWxD) mm	265 x 255 x 133
Weight (Kg)	1.36
IP Rating	22



EcoDesign
Lot 20 Compliant



ATC Defog Heaters

Eliminate steamed up Mirrors

Key Features Include:

- Self-adhesive, easy-to-fit heating pad
- Economical running costs
- Maintenance free
- Ultra slim design sits comfortably and discreetly behind mirror
- Wires into existing bathroom light fitting / fan
- Supplied with 1m cable



Say goodbye to blurred, steamy mirrors thanks to the ATC mirror defog heater. Simple to fit, highly economical to run – luxury without the price!

Technical Details

Model	ATC Defog Heaters			
Product Code	R-1111	R-1121	R-2121	R-2141
Colour	N/A	N/A	N/A	N/A

Electrical Specifications

Voltage (Volts)	230-240 Vac 1Ø	230-240 Vac 1Ø	230-240 Vac 1Ø	230-240 Vac 1Ø
Frequency (Hertz)	50	50	50	50
Power (Watts)	15	25	50	100
Running Current (Amps)	0.07	0.11	0.22	0.44
Insulation Class	CL.I	CL.I	CL.I	CL.I
Power Density (w/m ²)	200	200	200	200
Cable length (m)	1	1	1	1

Mounting & Installation

Installation	Adhesive to Mirror	Adhesive to Mirror	Adhesive to Mirror	Adhesive to Mirror
Dimensions (HxWxD) mm	252 x 274 x 1	274 x 574 x 1	519 x 524 x 1	524 x 1024 x 1
Connection thickness (mm)	5	5	5	5
Weight (Kg)	0.08	0.14	0.25	0.41
IP Rating	44	44	44	44

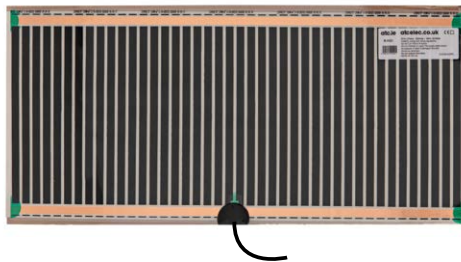

ATC Bathroom Range

A Heat Stat Room Thermostat & Under Floor Heating Stat

- Room thermostat complete with floor probe
- Touch sensitive controls
- 5°C to 35°C range
- Switches 16A resistive load
- Automatic timer with boost mode
- Can be used as an under floor heating thermostat

B Bavaro Downflow Heater

IP22 Bathroom Heater

- Smart Design
- 2 Output Stages 1Kw and 2Kw
- Pull Cord Switch & LED
- 30 Minute Countdown Timer
- Dual Safety Cut-out
- IP22 – Can be installed in Bathrooms

C Defog Heater

- Eliminate steamed up Mirrors
- Simple to fit
- Low cost
- Economical to run – just 0.1 cent per hour!
- Completely safe and maintenance free



Hospitality



Residential



Healthcare

D Pacific Heated Towel Radiators

Chrome or White

- Quick and easy to install
- Frost resistant to -35°C
- Fitted with electric pre-wired element
- Protected by a temperature sensor
- Suitable for connection to an external timer or intelligent building system

E Ecosun Under Floor Heating

It's like walking on sunshine

- Heating load is 160w/m²
- 15 mat sizes to suit various applications
- Sizes range from 0.5 m² to 16.25 m²
- Mats can be joined together at the thermostat
- Easy to install single end connection



Saving Energy
Reducing the
Carbon Footprint



A



B



C



D



E



RETURN TO INDEX

ATC **Welcome** Overdoor Heater



Infra-red remote control

Key Features Include:

- Attractive Matt Chrome finish
- 3 settings: Cool, Half Heat and Full Heat
- Hand held Infra-red Remote Control included
- Durable design
- Contact for remote switching



The Welcome Overdoor Heater provides comfortable warm air when you enter any premises. The powerful air velocity creates a barrier to the outside cold air. Ideal option for the Commercial, Retail and Hospitality sectors, this aesthetically pleasing Overdoor Heater has some key features that differentiates it from other Overdoor heaters.

Technical Details

Model	Welcome Overdoor Heater
Product Code	WEL3000
Colour	Silver/Black
Frequency (Hz)	50

Electrical Specifications

Voltage (Volts)	230-240 Vac 1Ø
Frequency (Hertz)	50
Power (Watts)	3000 / 1500 / 50 / 0
Running Current (Amps)	0/ 0.21 / 6.5 / 13
Insulation Class	CL.I

Product Specifications

Control	Onboard/ Hand Held IR Remote/ Volt free contact
Settings	Full Heat / Half Heat / Cool Down / Off
Pre-wired	1m cable

Mounting & Installation

Installation	Wall mounted
Dimensions (HxWxD) mm	140 x 600 x 200
Weight (Kg)	7
IP Rating	20



Hospitality



Commercial



[RETURN TO INDEX](#)

ATC Low Temperature Radiant Ceiling Heaters

Key Features Include:

- Energy efficient & low energy costs
- Draught and noise free
- Ceiling mounting allows flexible use of floor and wall space
- Designed for quick and easy installation on suspended ceilings
- Bracket supplied for easy mounting onto conventional ceiling
- Attractive white finish
- Two panel sizes available



Providing an economical and draught free means of heating in commercial premises, the ATC low temperature radiant ceiling heaters provide radiant warmth from above, designed to free up wall space that is both out of sight and out of reach.

Technical Details

Model	ATC Ecosun Low Temperature Radiant Panels	
Product Code	E300u	E600u
Colour	White	White

Electrical Specifications

Voltage (Volts)	230-240 Vac 1Ø	230-240 Vac 1Ø
Frequency (Hertz)	50	50
Power (Watts)	300	600
Running Current (Amps)	1.3	2.6
Insulation Class	CL.I	CL.I

Mounting & Installation

Installation	Ceiling / Surface*	Ceiling / Surface*
Dimensions (HxWxD) mm	30 x 592 x 592	30 x 592 x 1192
Weight (Kg)	5	10
IP Rating	44	44

* Ceiling Grid or Surface mounted, (Supplied with Ceiling Bracket)

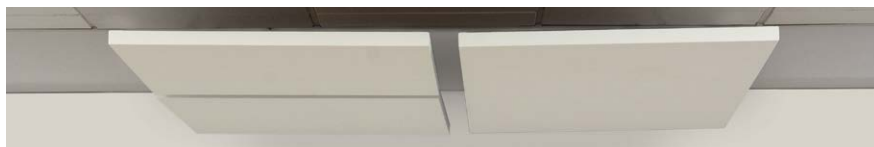

Low Temp Heater:

Easy control via the HeatStat Room Thermostat



Design Facility

We are committed to providing comprehensive technical support for all your radiant ceiling heating projects. We now offer the most comprehensive design service yet. Simple sketches and dimensions can be converted into a professional drawing plan and quotation. All plans can be electronically sent and received for maximum efficiency e-mail: sales@atc.ie

ATC High Temperature Radiant Ceiling Heaters

Key Features Include:

- Energy efficient
- Draught and noise free
- Can be ceiling or wall mounted with optional tilt wall brackets
- Optional protective grille available
- Attractive finish
- Three panel heat outputs available: 1800W, 2400W, 3600W



Providing an economical and draught free means of heating in commercial, agricultural and industrial premises.

Technical Details

Model	ATC Ecosun High Temperature Radiant Panels		
Product Code	S18-PLUS	S24-PLUS	S36-PLUS
Colour	White / Grey	White / Grey	White / Grey

Electrical Specifications

Voltage (Volts)	230-240 Vac 1Ø	230-240 Vac 1Ø	380-415 Vac 3Ø
Frequency (Hertz)	50	50	50
Power (Watts)	1800	2400	3600
Running Current (Amps)	7.8	10.4	5 (per Ø)
Insulation Class	CL.I	CL.I	CL.I

Mounting & Installation

Installation	Ceiling / Wall*	Ceiling / Wall*	Ceiling / Wall*
Dimensions (HxWxD) mm	60 x 250 x 1500	60 x 250 x 1500	60 x 350 x 1500
Weight (Kg)	9.9	9.9	13.9
IP Rating	X4	X4	X4

* Wall mounted with optional separate bracket

Ecosun Accessories

Code	Ecosun Accessories
5401785 -PLUS	Tiltable Wall Brackets for S18, S24 & S36 Heaters
5401792	Protective Grille for S18 & S24 Ecosun Heater
5401794	Protective Grille for S36 for Ecosun Heater

Design Facility

We are committed to providing comprehensive technical support for all your radiant ceiling heating projects. We now offer the most comprehensive design service yet. Simple sketches and dimensions can be converted into a professional drawing plan and quotation. All plans can be electronically sent and received for maximum efficiency e-mail: sales@atc.ie



ATC **Hot Top** Long Wave Radiant Heater

Discreet heating without light or glare



Key Features Include:

- Low profile aluminium finish
- Exceptional heat output
- Choose from 1800W or 2400W
- Silent Operation
- Discreet without any light or glare
- IP55 High Performance Protection
- Brackets and 3m Cable supplied



The ATC Hot Top Radiant Heater uses Long Wave technology to create a new experience in heating, offering a discreet presence without any light or glare. Specifically for use in partially covered outdoor areas.

Technical Details

Model	ATC Hot Top Long Wave Radiant Heater
Product Code	9824
Colour	Black

Electrical Specifications

Voltage (Volts)	230-240 Vac 1Ø
Frequency (Hertz)	50
Power (Watts)	2400
Running Current (Amps)	10.4
Insulation Class	CL.I

Mounting & Installation

Installation	Wall or Ceiling
Dimensions (HxWxD) mm	80 x 201 x 1010
Weight (Kg)	6.4
IP Rating	55

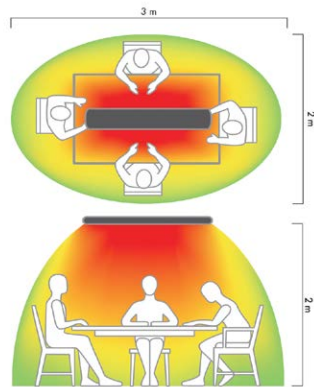

Temperature by Proximity to Heater

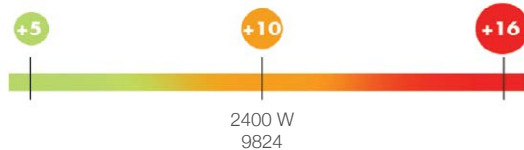



Outdoor Heating Range

Alfresco	106
Riviera	108
Sienna	110
Optional Mounting Brackets	112
Bluetooth Heating Controller	114
Heating Areas	116
Cost Savings	118



ATC **Alfresco** Outdoor Infrared Electric Heaters

Key Features Include:

- Easy to install
- Low running costs
- Even spread of instant heat
- Weatherproof IP55
- Silent running
- Wall bracket included
- Portable stand (optional)
- Time lag controller (optional)



An energy efficient, short wave infrared heater that can be used even in wet conditions, ideal for use in residential or hospitality settings.

Technical Details

Model	ATC Alfresco Outdoor Infrared Electrical Heaters	
Product Code	ALH1800	ALH1800-P-TRI
Colour	Black	Black

Electrical Specifications

Voltage (volts)	230-240 Vac 1Ø	230-240 Vac 1Ø
Frequency (Hertz)	50	50
Power (Watts)	1800	1800
Running Current (Amps)	7.8	7.8
Insulation Class	CL.I	CL.I
Lamp Type	Tungsten Quartz	Tungsten Quartz
Emmission	IR-A	IR-A

Product Specifications

Mounting Height (M)	2.3	1.8-2.1 on tripod
Heating Area (M ²)	6	6
Minimum Cable size	3 x 1.5 ²	3 x 1.5 ²
Supplied with or without cable	Without	With (4M) – Prewired with plug
Supplied with integral switch	No	Yes
Dimmable (With Controller)	Yes	Yes
With / Without grill	With	With
Compatible with Tripod	No	Yes
Vertical Mounting	No	No
Replaceable Lamp	Yes	Yes
Supplied with hanging chain	Yes	No

Mounting & Installation

Installation	Wall / Ceiling Hanging	Free Standing
Dimensions (HxWxD) mm	120 x 830 x 38	120 x 830 x 38
Tripod height (M)	N/A	2.1
Clearance Required above (mm)	300	300
Weight (Kg)	1.7	12.5
IP Rating	55	55



Commercial



Hospitality



Residential



Sports & Leisure



* Lamps are consumables and not covered under warranty

[RETURN TO INDEX](#)

ATC **Riviera** Outdoor Quartz Infrared Electric Heaters



Image shows 4kW Riviera Heater

Key Features Include:

- Easy to install
- Low running costs
- Even spread of instant heat
- Weatherproof IP55
- Silent running
- Available in silver and black
- Multiple mounting heights
- Multiple mounting options
 - wall, ceiling, hung



A high performance infrared electric heater that is suitable for many applications, industries and environments. Unique in their mounting abilities – can be wall or ceiling mounted, or hung from a height to provide heat in unusual locations.

Technical Details

Model	Riviera 2000W	Riviera 4000W	Riviera 6000W
Product Code	RIV200 RIV200-SL	RIV400 RIV400-SL	RIV600 RIV600-SL
Colour	Black Silver	Black Silver	Black Silver

Electrical Specifications

Power output (Watts)	2000	4000	6000
Voltage	220-240	220-240	220-240
Frequency (Hertz)	50-60	50-60	50-60
Current (Amps)	9	18	3 x 9
Lamps	1	2	3
Lamp Arrangement	Single	Stacked Vertically	Stacked Vertically
Lamp type	Gold	Gold	Gold
Emmission	IR-A	IR-A	IR-A

Mounting and Installation

Installation	Wall/Ceiling/Hanging	Wall/Ceiling/Hanging	Wall/Ceiling/Hanging
Mounting height	2.5-3	3-4	3-4
Heating Area (M ² * @45°	10	24	32
Heating Area (M ² * when hung	10 @ 3m	32 @ 4m	48 @ 4m
Minimum cable size	3 x 1.5 ²	3 x 2.5 ²	5 x 1.5 ²
Supplied with or without cable	Without	Without	Without
Lamps switchable or all together	N/A	All Together	All Together
Dimmable (With controller)	Yes	Yes	Yes
With/without grill	With	With	With

Dimensions & Weight

Dimensions (HxWxD) mm	235 x 496 x 313	375 x 496 x 313	515 x 496 x 313
Weight (Kg - Nett)	2.2	3.0	3.8
IP Rating	IP55	IP55	IP55



Commercial



Hospitality



Residential



Sports & Leisure



Saving Energy
Reducing the
Carbon Footprint



2
YEAR
WARRANTY

* Lamps are consumables and not covered under warranty

[RETURN TO INDEX](#)

ATC **Sienna** Outdoor Quartz Infrared Electric Heaters



Image shows 2.2kW Sienna Heater

Key Features Include:

- Easy to install – wall mounted only
- Low running costs
- Even spread of instant heat
- Weatherproof IPX5
- Silent running
- Available in silver and black
- 2.2kW models come complete with protective grill
- Pre-wired with cable (5m on 2.2kW and 1.5m on 4kW)



High performance, superior finished infrared outdoor heater fitted with low glare lamps to provide a comfortable level of heat. Suitable for a large range of applications, such as commercial, hospitality and sports & leisure.

Technical Details

Model	Sienna 2200	Sienna 4000
Product Code	SIE2.2KW-BL SIE 2.2KW-SL	SIE4KW-BL SIE4KW-SL
Colour	Black Silver	Black Silver

Electrical Specifications

Power output (Watts)	2200	4000
Voltage	220-240	220-240
Frequency (Hertz)	50-60	50-60
Current (Amps)	10	18
Lamps	1	2
Lamp Arrangement	Single	Stacked Vertically
Lamp type	Low Glare	Low Glare
Emmission	IR-A	IR-A

Mounting and Installation

Installation	Wall (@45° Only)	Wall (@45° Only)
Mounting height	2.7 - 3m	3-3.5m
Heating Area (M ²)* @45°	10 - 15	20 - 32
Minimum cable size	3 x 1.5 ²	2x (3 x 1.5 ²)
Supplied with or without cable	With (5m)	With (2 x 1.5m)
Lamps switchable or all together	N/A	Separate supplies for each lamp
Dimmable (With controller)	Yes	Yes

Dimensions & Weight

Dimensions (HxWx D) mm	195 x 465 x 113	195 x 910 x 113
Weight (Kg - Nett)	2.45	4.05
IP Rating	IPX5	IPX5



Commercial



Hospitality



Residential



Sports & Leisure



* Lamps are consumables and not covered under warranty

Optional Mounting Brackets

Sienna Outdoor Optional Mounting Brackets



SIE-BL66-Pole
SIE-SL66-Pole
SIE-BL100-Pole
SIE-SL100-Pole



SIE-CI41-Short-Hook
SIE-SL41-Short-Hook



SIE-CI41-Long-Hook
SIE-SL41-Long-Hook



SIE-CI100-Tri
SIE-SL100-Tri



SIE-CI-Standard
SIE-SL-Standard



SIE-BL-Expand-Bracket
SIE-SL-Expand-Bracket





Product Code	Description	Colour	Dimensions
SIE-BL66-Pole	Pole Bracket. Opens up to 66mm	Black	34-66mm diameter
SIE-SL66-Pole	Pole Bracket. Opens up to 66mm	Silver	34-66mm diameter
SIE-BL100-Pole	Pole Bracket. Opens up to 100mm	Black	70-100mm diameter
SIE-SL100-Pole	Pole Bracket. Opens up to 100mm	Silver	70-100mm diameter
SIE-CI41-Short-Hook	150mm Hook for under awnings and parasols. Opens up to 41mm	Cast Iron	150 x 50 x 47mm
SIE-SL41-Short-Hook	150mm Hook for under awnings and parasols. Opens up to 41mm	Silver	150 x 50 x 47mm
SIE-CI41-Long-Hook	300mm Hook for under awnings and parasols. Opens up to 41mm	Cast Iron	300 x 50 x 47mm
SIE-SL41-Long-Hook	300mm Hook for under awnings and parasols. Opens up to 41mm	Silver	300 x 50 x 47mm
SIE-CI100-Tri	Triple bracket for 3 heaters on Pole with Hinged opening Max 100mm pole	Cast Iron	40-130mm diameter
SIE-SL100-Tri	Triple bracket for 3 heaters on Pole with Hinged opening Max 100mm pole	Silver	40-130mm diameter
SIE-CI-Standard	Standard bracket	Cast Iron	150 x 90 x 30mm
SIE-SL-Standard	Standard bracket	Silver	150 x 90 x 30mm
SIE-BL-Expand-Bracket	Expanding Wall Bracket	Black	500 x 40 x 40mm
SIE-SL-Expand-Bracket	Expanding Wall Bracket	Silver	500 x 40 x 40mm



Extendable bracket closed



Extendable bracket open

ATC **Bluetooth** Heating Controller



Key Features Include:

- Controls radiant heaters up to 4.4kW
- Easy-to-use app available on App Store & Google Play
- Delay off timer feature
- Zone control when using multiple controllers
- Separate IR remote provides 5-step control



The Bluetooth Heating Controller allows total control of radiant heating such as the full ATC Outdoor Heating Range, up to 4.4kW. Controllable via app or remote control.

Technical Details

Product Code:	INFRA4400
Electrical Supply:	220 – 240vAC 50/60 Hz Single phase
Max Rating:	4.4kW
Control Type:	0-100% Variable output (Bluetooth) 5 Step (IR Control)
Dimensions:	195 x 118 x 63mm (whd)
IP Rating:	IP56
Connections:	3x L/N/E 4mm ² Screw Connections 1x Supply, 2x Output Joined
Soft Start	Yes



Commercial



Hospitality



Residential



Sports & Leisure



In cases where Bluetooth is not used, the INFRA4400 comes with a separate IR remote providing 5-step control.



Heating Area Sienna

Heating Area m²

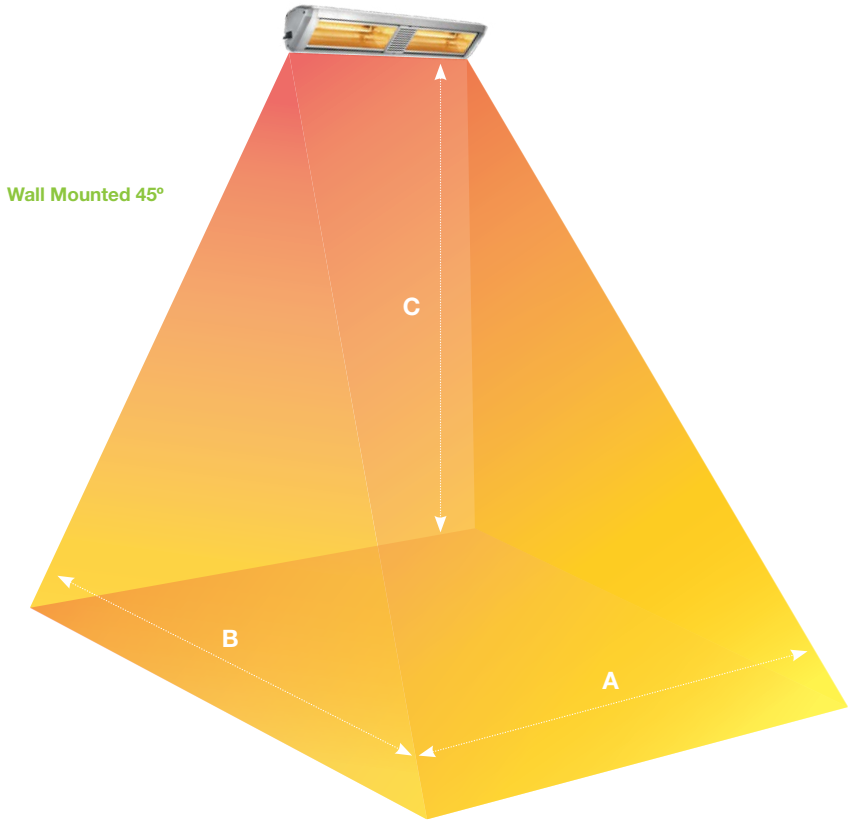

Model	Wall Mounted 45°		
	A	B	C
SIE2.2KW	5	3	3
SIE4KW	8	4	4

It is recommended to install Outdoor radiant heaters protected from strong breezes or crosswinds. Based on average ambient temperature of 10°C.



Heating Area Riviera

Heating Area m²

Wall Mounted 45°

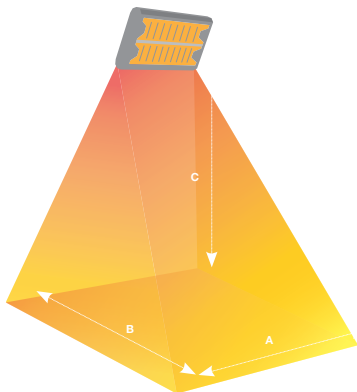

Model	Wall Mounted 45°		
	A	B	C
RIV200	5	2	3
RIV400	8	3	4
RIV600	8	4	4

Ceiling Mounted

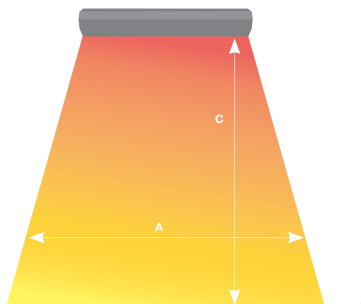

Side View

Model	Ceiling Mounted		
	A	B	C
RIV200	5	2	3
RIV400	8	4	4
RIV600	8	6	4

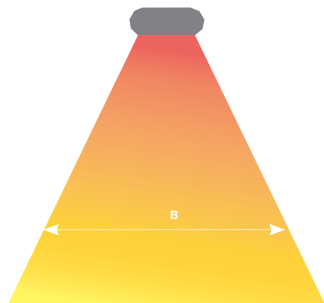

End View

It is recommended to install Outdoor radiant heaters protected from strong breezes or crosswinds. Based on average ambient temperature of 10°C.

Cost Savings

Alfresco Cost Savings



Annual Energy Cost: **€1,373.91**
Annual CO₂ Output: **749kg**

Annual Energy Cost: **€6174.00**
Gas Annual CO₂ Output: **5802kg**

Savings per Year: €4,800.09*

Riviera Cost Savings

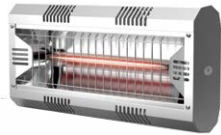

Annual Energy Cost: **€1,526.57**
Annual CO₂ Output: **833kg**

Annual Energy Cost: **€6174.00**
Gas Annual CO₂ Output: **5802kg**

Savings per Year: €4,647.43*

Sienna Cost Savings



Annual Energy Cost: **€3,053.13**
Annual CO₂ Output: **1665kg**

Annual Energy Cost: **€6174.00**
Gas Annual CO₂ Output: **5802kg**

Savings per Year: €3,120.87*

*Based on heaters operating 7 days @ 6 hours per day, 42 weeks per year. Figures correct as of November 2022. Calculations made based on 1.8kW Alfresco / 2kW Riviera / 4kW Sienna heaters at energy cost of €0.43 / kW. Gas heaters burning 1.1kg gas / hour, with price of 11kg bottle @ €35.



The **Riviera** heaters are very good and give off excellent heat. It was really helpful that we could hang the 4 Kw in the marquee which gives off excellent heat and creates a lovely atmosphere. **PM**



The six **Sienna** heaters that we installed on the balcony of the Clubhouse have gone down a treat with the members. It has transformed the area as the members are much happier dining outside in the nice warm area. I think some of them might be in touch themselves for their houses. **JB**

Look at what people are saying about **ATC Outdoor Heating**

The **Alfresco Portable** heat is a god send for the balcony in our apartment. Just plug it in and the whole balcony is warm. **CD**



Due to recent restrictions, we needed to transform our outdoor area so we could maximise our space and keep our staff and patrons safe and warm. The **Alfresco** heaters suited the job perfectly and were extremely cost effective. **TH**



Contact
sales@atc.ie
for information
on **ATC Air Curtains**

FEEN
EINE

atc[®]





Domestic Ventilation

Punto Standard Fans 124

Punto EVO Fans 126

Punto Filo Fans 128

Punto Ghost Fans 129

Punto Four 129

Record M10/4T 130





[RETURN TO INDEX](#)

Punto Standard Fans



- Axial fan
- IPX4 Rated

Technical Details

Code	Model	Watts	Amps	l/s	Pa	m3/hr
11201	Punto M100/4"	18	0.1	25	29	90
11641	Punto M100/4" P	18	0.1	25	29	90
11211	Punto M100/4" T	18	0.1	25	29	90
11681	Punto M100/4" PIR	18	0.1	25	29	90
11683	Punto M100/4" A PIR	18	0.1	25	29	90
11221	Punto M100/4" A	18	0.1	25	29	90
11646	Punto M100/4" A P	18	0.1	25	29	90
11231	Punto M100/4" A T	18	0.1	25	29	90
11603	Punto M100/4" T HCS	18	0.1	25	29	90
11613	Punto M100/4" A T HCS	18	0.1	25	29	90
11203	Punto M100/4" 12V	18	0.1	25	29	90
11223	Punto M100/4" A 12V	18	0.1	25	29	90
11683	Punto M100/4" A PIR	18	0.1	25	29	90
11401	Punto M150/6"	30	0.15	93.1	59	335.16
11851	Punto M150/6" P	30	0.15	93.1	59	335.16
11411	Punto M150/6" T	30	0.15	93.1	59	335.16
11881	Punto M150/6" PIR	30	0.15	93.1	59	335.16
11421	Punto M150/6" A	30	0.15	93.1	59	335.16
11856	Punto M150/6" A P	30	0.15	93.1	59	335.16
11431	Punto M150/6" A T	30	0.15	93.1	59	335.16
11693	Punto M150/6" T HCS	30	0.15	93.1	59	335.16
11697	Punto M150/6" A T HCS	30	0.15	93.1	59	335.16

Product Accessories

Code	Model	For Model
22131	Punto Window Kit 100/4	11221-11231-11613-11646-11223-11683
22133	Punto Window Kit 150/6	11421-11431-11697-11856
22154	Punto Gasket 100/4	11201-11211-11603-11681-11221-11231-11613-11683
22156	Punto Gasket 150/6	11401-11411-11693-11881-11421-11697
22150	12V Transformer	All 12 V models
22151	12V Transformer T	All 12 V models
22152	12V Transformer P	All 12 V models
22157	12V Transformer T HCS	All 12 V models



Dimensions (mm)

	A	B	C	D	E
100 / 4"	159	160	100	47	99
150 / 6"	214	215	117	47	156

Wall or ceiling mounted fans for intermittent ventilation of toilets (8 l/s), bathrooms (15 l/s), utility rooms (40 l/s) or kitchens (60 l/s).

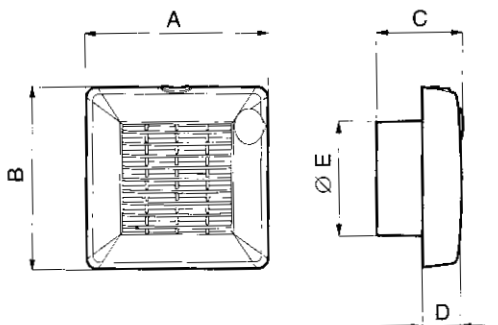

Product Code Terminology

P	Pullcord
T	Timer
A	Auto Shutter
LL	LongLife
PIR	Passive Infrared
HCS	Humidity Control System
I	Inbuilt (Recessed)
R	Reversible
M	Metal
E	ERP Compliant
Q	Quiet
D	Dual Speed
TP	Timer Programable
ES	Energy Saving
V0	Self-Extinguishing Plastic
12V	12V Low Voltage Fan

12 V Power Supply

	A	B	C
100 / 4"	159	160	100

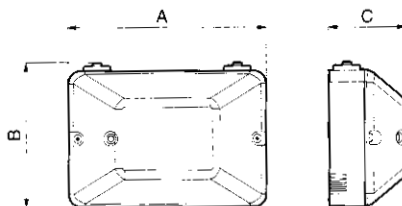

Punto Evo Flexo



- Mixed flow fan with low decibel rating
- Straightening vanes to improve airflow
- Wall installations only
- Butterfly backdraught shutter
- IP45 Rated

Technical Details

Code	Model	Watts	Amps	l/s	Pa	m ³ /hr
11313	Punto Evo Flexo MEX 100/4" LL	9	0.052	25	39.23	90
11314	Punto Evo Flexo MEX 100/4" LLT	9	0.052	25	39.23	90

Punto Evo

- Mixed flow fan with low decibel rating
- Straightening vanes to improve airflow
- Butterfly backdraught shutter
- IP45 Rated

Technical Details

Code	Model	Watts min-max	Amps min-max	l/s min-max	Pa min-max	m ³ /hr min-max
11260	Punto Evo ME 100/4" LL	5-9	0.039-0.052	18.1-26.4	24.52-46.09	65.16-95.04
11264	Punto Evo ME 100/4" T LL	5-9	0.039-0.052	18.1-26.4	24.52-46.09	65.16-95.04
11261	Punto Evo ME 100/4" TP LL	5-9	0.039-0.052	18.1-26.4	24.52-46.09	65.16-95.04
11262	Punto Evo ME 100/4" T LL HCS	5-9	0.039-0.052	18.1-26.4	24.52-46.09	65.16-95.04
11263	Punto Evo ME 100/4" LL PIR	5-9	0.039-0.052	18.1-26.4	24.52-46.09	65.16-95.04

Punto Evo Gold



- Mixed flow fan with low decibel rating
- Straightening vanes to improve airflow
- Butterfly backdraught shutter
- IP45 Rated

Technical Details

Code	Model	Watts min-max	Amps min-max	l/s min-max	Pa min-max	m ³ /hr min-max
11306	Punto Evo ME 100/4" Gold	5-9	0.039-0.052	18.1-26.4	24.52-46.09	65.16-95.04
11316	Punto Evo ME 100/4" T Gold	5-9	0.039-0.052	18.1-26.4	24.52-46.09	65.16-95.04
11307	Punto Evo ME 100/4" Rose Gold	5-9	0.039-0.052	18.1-26.4	24.52-46.09	65.16-95.04
11317	Punto Evo ME 100/4" T Rose Gold	5-9	0.039-0.052	18.1-26.4	24.52-46.09	65.16-95.04
11308	Punto Evo ME 100/4" Black Gold	5-9	0.039-0.052	18.1-26.4	24.52-46.09	65.16-95.04
11318	Punto Evo ME 100/4" T Black Gold	5-9	0.039-0.052	18.1-26.4	24.52-46.09	65.16-95.04
11309	Punto Evo ME 100/4" White Gold	5-9	0.039-0.052	18.1-26.4	24.52-46.09	65.16-95.04
11319	Punto Evo ME 100/4" T White Gold	5-9	0.039-0.052	18.1-26.4	24.52-46.09	65.16-95.04



Dimensions (mm)

Model	Evo	Evo Gold	Evo Flexo
A	173	173	173
B	173	173	73
C	126	126	126
D	98	98	98
E	61.5	61.5	61.5
F	50	50	50
G	132	132	132
H	132	132	132
L	3.5	3.5	3.5
Kg	0.6	0.6	0.6

Wall or ceiling mounted fans for intermittent ventilation of toilets (8 l/s), bathrooms (15 l/s), utility rooms (40 l/s) or kitchens (60 l/s).

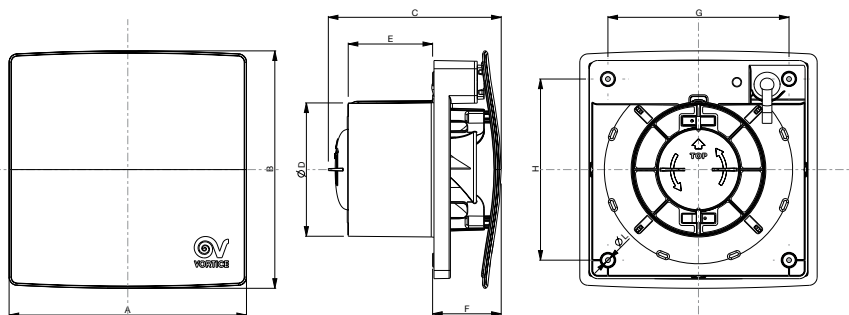

Product Code Terminology

P	Pullcord
T	Timer
A	Auto Shutter
LL	LongLife
PIR	Passive Infrared
HCS	Humidity Control System
I	Inbuilt (Recessed)
R	Reversible
M	Metal
E	ERP Compliant
Q	Quiet
D	Dual Speed
TP	Timer Programmable
ES	Energy Saving
V0	Self-Extinguishing Plastic
12V	12V Low Voltage Fan

Punto Filo

Wall or ceiling mounted fans for intermittent ventilation of toilets (8 l/s), bathrooms (15 l/s), utility rooms (40 l/s) or kitchens (60 l/s).



- Axial fan with ultra slim front grille
- Butterfly backdraught shutter
- IPX4 Rated

Technical Details

Code	Model	Watts	Amps	l/s	Pa	m ³ /hr
11123	Filo MF 100/4"	15	0.09	24	29	86.4
11127	Filo MF 100/4" T	15	0.09	24	29	86.4
11139	Filo MF 100/4" T HCS	15	0.09	24	29	86.4
11185	Filo MF 100/4" PIR	15	0.09	24	29	86.4
11125	Filo MF 150/6"	28	0.15	93	59	334.8
11129	Filo MF 150/6" T	28	0.15	93	59	334.8
11176	Filo MF 150/6" T HCS	28	0.15	93	59	334.8

Product Accessories

Code	Model	For Model
22162	Filo Gasket 100/4	11123-11127-11139-11185
22164	Filo Gasket 150/6	11125-11129-11176

Dimensions (mm)

	A	B	C	D	KG
100 / 4"	159	17	77	98	0.51
150 / 6"	214	17	96	156	0.97

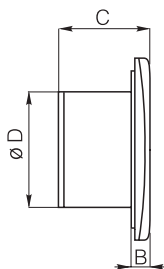
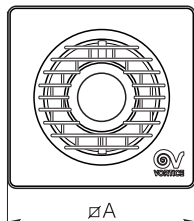

Product Code Terminology

P	Pullcord
T	Timer
A	Auto Shutter
LL	LongLife
PIR	Passive Infrared
HCS	Humidity Control System
I	Inbuilt (Recessed)
R	Reversible
M	Metal
E	ERP Compliant
Q	Quiet
D	Dual Speed
TP	Timer Programmable
ES	Energy Saving
V0	Self-Extinguishing Plastic
12V	12V Low Voltage Fan



Punto Ghost



- Axial in line fan
- IPX4 Rated

Punto In-Line axial fans are suitable for ducted installations.

Technical Details

Code	Model	Watts	Amps	l/s	Pa	m ³ /hr
11100	Ghost MG 100/4" LL	18	0.10	22.2	25	79.92
11101	Ghost MG 100/4" T LL	18	0.10	22.2	25	79.92
11104	Ghost MG 150/6" LL	30	0.18	88.9	69	320.04
11105	GhostMG 150/6" T LL	30	0.18	88.9	69	320.04

Product Accessories

Code	Model	For Model
22140	Grille Kit for Ghost 100/4	11100-11101
22142	Grille Kit for Ghost 150/6	11104-11105
22259	Mounting Foot 100/4	11100-11101
22261	Mounting Foot 150/6	11104-11105

Dimensions (mm)

	A	B	C
100 / 4" LL	99	92	100
100 / 4" LL T	99	96.5	117
150 / 6" LL	155	110	
150 / 6" LL T	155	110	

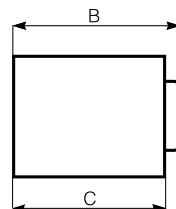
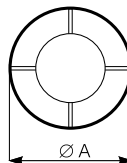

Punto Four



- Axial fan with low power consumption and stylish front grille
- Wall installations only
- Butterfly backdraught shutter
- IPX4 Rated

Technical Details

Code	Model	Watts	Amps	l/s	Pa	m ³ /hr
11145	Punto Four MFO 100/4"	15	0.09	24	29	86.4
11146	Punto Four MFO 100/4" T	15	0.09	24	29	86.4

Record

Wall mounted fans for intermittent ventilation of bathrooms, toilets, kitchens or utility rooms. Only for 'through the wall ventilation'.



- Axial rectangular fan
- Wall installations only
- IP20 Rated

Technical Details

Code	Model	Watts	Amps	l/s	Pa	m ³ /hr
11630	Record M10/4" T	16	0.09	23.6	41	84.96

Product Code Terminology

P	Pullcord
T	Timer
A	Auto Shutter
LL	LongLife
PIR	Passive Infrared
HCS	Humidity Control System
I	Inbuilt (Recessed)
R	Reversible
M	Metal
E	ERP Compliant
Q	Quiet
D	Dual Speed
TP	Timer Programable
ES	Energy Saving
V0	Self-Extinguishing Plastic
12V	12V Low Voltage Fan



[RETURN TO INDEX](#)



Domestic Centrifugal Ventilation

Quadro Fan Range 134

Ariett Fan Range 138

Angol & Axial K Fans 139





[RETURN TO INDEX](#)

Quadro



- Centrifugal fan with surface and recessed options and stylish front grille
- Butterfly backdraught shutter
- IPX4 Rated

Technical Details

Code	Model	Watts min-max	Amps min-max	l/s min-max	Pa min-max	m³/hr min-max
11936	Quadro Micro 100	20-28	0.10-0.13	18-25	157-216	64.8-90
11940	Quadro Micro 100 T	20-28	0.10-0.13	18-25	157-216	64.8-90
11945	Quadro Micro 100 T HCS	20-28	0.10-0.13	18-25	157-216	64.8-90
12017	Quadro Micro 100 I	20-27	0.12-0.15	21-31	196-245	75.6-111.6
12018	Quadro Micro 100 IT	20-27	0.12-0.15	21-31	196-245	75.6-111.6
12065	Quadro Micro 100 IT HCS	20-27	0.12-0.15	21-31	196-245	75.6-111.6
12220	Quadro Super	50-105	0.36-0.50	39-74	226-490	140.4-266.4
12221	Quadro Super T	50-105	0.36-0.50	39-74	226-490	140.4-266.4
12222	Quadro Super T HCS	50-105	0.36-0.50	39-74	226-490	140.4-266.4
12223	Quadro Super I	50-115	0.36-0.50	38-79	196-476	136.8-284.4
12224	Quadro Super IT	50-115	0.36-0.50	38-79	196-476	136.8-284.4

Product Accessories

Code	Model	For Model
22491	Quadro Micro Ceiling Kit	12017-12018-12065
22493	Quadro Super Ceiling Kit	12223, 12224

Dimensions (mm)

	A	B	C	I	E	D	G	F	L	H	T	ø	KG
MICRO 100	239	195	197	100	74	85	60	64	20	97	117	92.5/97	1.80
SUPER	290	236	239	125	92	108	81	87	20	144	164	92.5/97	3.77

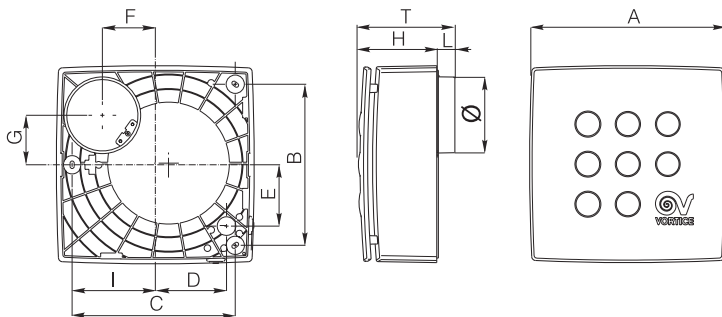

Next Day Delivery Across Ireland*



353 (1) 467 8301 | sales@atc.ie | [🌐 atc.ie](https://www.atc.ie)

*For orders placed by 2.30pm

Quadro Evo

Centrifugal fans for residential use, available in versions for wall / ceiling mounting or recessed installation, compliant with DIN 18017-3 standard, which specifies particular requirements in terms of performance and fire resistance. Ultra low noise emission levels and high degree of water ingress protection (IP45). Fan Centers and Casings purchased separately.



Technical Details

Code	Model	Watts	Amps	Max Airflow m ³ /h	l/s	Max Pressure Pa mmH ₂ O	Pa	Max
11522	QE 100 LL	26	0.17	100	27.8	36	353	50
11527	QE 100 LL T	26	0.17	100	27.8	36	353	50
11533	QE 100 LL TP	26	0.17	100	27.8	36	353	50
11538	QE 100 LL TP HCS	26	0.17	100	27.8	36	353	50
11545	QE 100 LL T PIR	26	0.17	100	27.8	36	353	50
11524	QE 100/60 LL	26	0.17	100	27.8	36	353	50
11531	QE 100/60 LL T	26	0.17	100	27.8	36	353	50
11535	QE 100/60 LL TP	26	0.17	100	27.8	36	353	50
11542	QE 100/60 LL TP HCS	26	0.17	100	27.8	36	353	50
11547	QE 100/60 LL T PIR	26	0.17	100	27.8	36	353	50

Dimensions (mm)

	A	B	C	D	E	F	G	H
Surface Version	262	262	123	73	73	79	71.5	76
Recessed Version	262	262	114.5	80	73	79	71.5	90

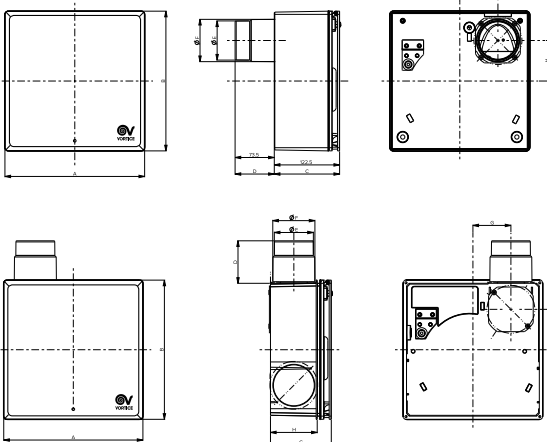



Cases

Code	Surface Version	Description
11561		Basic case for surface (wall/ceiling) installation, made of ABS plastic. Spigot made of ABS plastic with integrated backdraught shutter.
11563		Basic case for surface (wall/ceiling) installation, made of ABS plastic. Spigot made of Stainless Steel with integrated K90 backdraught shutter.
Code	Recessed Version	
11560		Basic case for recessed installation, made of ABS plastic with Spigot made of ABS with integrated backdraught shutter.
11562		Basic case for recessed installation, made of ABS plastic with Stainless steel spigot, integrating a K90 fireproof valve and backdraught shutter.
11564		Fireproof K90 casing for recessed installation and rear discharge. Stainless steel spigot, with integrated K90 fireproof valve and backdraught shutter.

Product Code Terminology

P	Pullcord
T	Timer
A	Auto Shutter
LL	LongLife
PIR	Passive Infrared
HCS	Humidity Control System
I	Inbuilt (Recessed)
R	Reversible
M	Metal
E	ERP Compliant
Q	Quiet
D	Dual Speed
TP	Timer Programable
ES	Energy Saving
V0	Self-Extinguishing Plastic
12V	12V Low Voltage Fan

Ariett

The Ariett standard and long life wall or ceiling mounted centrifugal fans are ideal for intermittent or continuous ventilation of bathrooms, toilets or kitchens. This range is available with standard or long life motors (30,000 hours).

- Centrifugal fan with surface and recessed options
- IPX4 Rated

Technical Details (Surface Fans)

Code	Model	Watts	Amps	l/s	Pa	m ³ /hr
11976	Ariett T	18	0.14	19.4	118	69.84
11965	Ariett LL	18	0.14	19.4	118	69.84
11966	Ariett LL T	18	0.14	19.4	118	69.84

Technical Details (Recessed Fans)

Code	Model	Watts	Amps	l/s	Pa	m ³ /hr
12012	Ariett I	19	0.13	19.4 a -22.2 b	108	69.84-79.92
12013	Ariett IT	19	0.13	19.4 a-22.2 b	108	69.84-79.92

Rear (a) or Side outlet (b)

Ariett Habitat

- Centrifugal
- IPX4 Rated

Technical Details

Code	Model	Watts	Amps	l/s	Pa	m ³ /hr
12000	Ariett Habitat15/30 LL	5-8	0.02-0.04	5.6-11.9	78-98	20.16-42.84
12001	Ariett Habitat 20/75 LL	6-25	0.03-0.17	7.5-23.6	78-118	27-84.96

Product Accessories

Code	Model
G2R2SNI230(AC)S	8-Pin Relay
P2RFZ08	8 Pin Relay Base

Note: The Ariett Habitat fan must be installed with the following items: G2RSNI230AC(S) 8 pin Relay and P2RFZ08 relay base. Please contact technical@atc.ie for more details.



Angol and Axial K

The Axial K in-line fan is suitable for ducted installations through the ceiling via ceiling valves. Ideal for bathrooms, toilets or utility rooms in apartments, houses or commercial premises. Ideal for long duct applications up to 10m.



- Centrifugal in-line fan
- IPX4 Rated

Technical Details

Code	Model	Watts	Amps	l/s	Pa	m ³ /hr
110904	Axial K	27	0.13	37.5	167	135
10204	Angol K	35	0.12-0.16	23.9-38.9	132-157	86-140
10205	Angol K R	18	0.15	16.7	41	60
10206	Angol K R T	18	0.15	16.7	41	60

Product Code Terminology

LL	LongLife
I	Inbuilt (Recessed)
R	Reversible
T	Tri (Three-Phase)



Commercial Ventilation

Vario Window / Wall Fans	142
Lineo Fans Range	144
CA In Line Fans Range	148
Nordik Ceiling Sweep Fan	150
Gordon Wall Mounted Oscillating Fan	150
Controllers & Environmental Sensors	151





RETURN TO INDEX

Vario



- Axial reversible supply and extract fan (Pullcord versions extract only)
- Sensors available - see page 151
- IPX4 Rated

The Vario range of window / wall fans provide intermittent ventilation for shops, cafes, restaurants, pubs, gyms, sports clubs, schools, offices and much more. This is a versatile and popular range of fans for through the wall / window applications. The standard range is fitted with bush bearing motors for regular intermittent operations.

Technical Details

Code	Model	Watts	Amps	l/s	m ³ /hr
		min-max	min-max	Extract - Intake	Extract - Intake
12611	Vario 150/6" P	18	0.10	65.3	235.1
12612	Vario 150/6" AR	25	0.11	65.3 /41.7	235-150
12613	Vario 150/6" ARI	25	0.11	61.1/36.	220-130
12614	Vario 150/6" P-LL-S	32	0.16	105.6	380
12615	Vario 150/6" AR-LL-S	35	0.17	105.6/59.7	380-215
12616	Vario 150/6" ARI-LL-S	35	0.17	97.2/55.6	350-200
12451	Vario 230/9" P	22	0.10	133	479
12452	Vario 230/9" AR	26	0.13	133 /86	748-310
12453	Vario 230/9" ARI	26	0.13	125/83.3	450
12454	Vario 230/9" P-LL-S	32-38	0.18	194.4	700
12455	Vario 230/9" AR-LL-S	35-40	0.19	194.4/102.8	700-370
12456	Vario 230/9" ARI-LL-S	35-40	0.19	188.9/97.2	680-350
12412	Vario 300/12" AR	45	0.21	292/194.4	1051-700
12413	Vario 300/12" ARI	45	0.21	333.3/236.1	1200-850
12415	Vario 300/12" AR-LL-S	75-90	0.41	458.3/255.6	1650-920
12416	Vario 300/12" ARI-LL-S	75-90	0.41	486.1/277.7	1750-1000

Product Accessories*

Code	Model	For Model
46516	Flexible Duct,10m, 175mm dia	6" Varios
46526	Flexible Duct,10m, 250mm dia	9" Varios
46265	Flexible Duct,10m, 305mm dia	12" Varios
46617	Wall Liner (Galv) - 150/6", 275mm, 187mm dia	
46618	Wall Liner (Galv) - 230/9", 275mm, 259mm dia	
46619	Wall Liner (Galv) - 300/12", 275mm, 326mm dia	
13018	Extension Rods Kit MU**	
13001	Roof Cowl Kit TE 150/6"	
13002	Roof Cowl Kit TE 230/9"	
13003	Roof Cowl Kit TE 300/12"	
13015	Deep Wall Kit ML 150/6"	
13016	Deep Wall Kit ML 230/9"	



Product Accessories Continued

Code	Model
13017	Deep Wall Kit ML 300/12"
13012	Flush Mount Panel/Ceiling Kit SO 150/6"/230/9"
13014	Flush Mount Panel/Ceiling Kit SO 300/12"
13027	Spigot Plate Kit TC 150/6"
13028	Spigot Plate Kit TC 230/9"
13029	Spigot Plate Kit TC 300/12"
12943	CR5 5 Speed Controller, reversible**
20125	Vario CO ₂ Sensor

*Non stock items, contact sales for lead time

** Stock item

Dimensions (mm)

Window and wall, standard and longlife fans

A	B	C	D	E Min/Max	Window/Wall	Kg
215	218	31	97.5	2/38	185-190	2.07
294	297	31	130	2/38	257-262	3.45
390	390	31	147	2/38	324-329	6.13

Built-in, standard and longlife fans

A	B	C	D	Hole Through Wall (Min)	Kg
300	9.5	10.5	135	260-265	2.52
400	10	11	180	335-340	3.45
495	10.5	11.5	210	435-440	7.2

Product Code Terminology

P	Pullcord
T	Timer
A	Auto Shutter
LL	LongLife
PIR	Passive Infrared
HCS	Humidity Control System
I	Inbuilt (Recessed)
R	Reversible
M	Metal
E	ERP Compliant
Q	Quiet
D	Dual Speed
TP	Timer Programmable
ES	Energy Saving
V0	Self-Extinguishing Plastic
12V	12V Low Voltage Fan

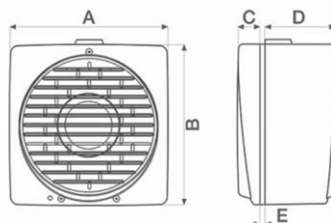

Window and Wall Fans

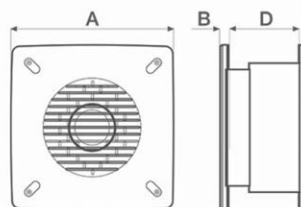

Built-In Fans

Lineo



- Mixed flow in-line fan
- 2 speed
- IP44 Rated

The Lineo mixed flow in-line fans are ideal for duct mounted ventilation systems requiring high pressure, good air flow and low noise levels. These fans are silent running and have compact overall dimensions. The fans are two speed and are available with adjustable timer. The Lineo range is splash proof IPX4, double insulated and eco-friendly.

Technical Details

Code	Model	Watts	Amps	l/s	Pa	m ³ /hr
		min-max	min-max	min-max	min-max	min-max
17144	Lineo 100	20-23	0.09-0.11	50-70.8	127.5-161.9	180-254.8
17185	Lineo 100 T	20-23	0.09-0.11	50-70.8	127.5-161.9	180-254.8
17143	Lineo 100 Q	12-15	0.05-0.9	43.1-55.6	63.8-73.6	155.1-200.1
17184	Lineo 100 Q T	12-15	0.05-0.9	43.1-55.6	63.8-73.6	155.1-200.1
17146	Lineo 150	40-58	0.18-0.26	106.9-152.8	206-264.9	384.84-550
17187	Lineo 150 T	40-58	0.18-0.26	106.9-152.8	206-264.9	384.8-550
17180	Lineo 200	80-110	0.34-0.49	226.4-315.3	210.9-294.2	815-1135
17177	Lineo 200 T	80-110	0.34-0.49	226.4-315.3	210.9-294.2	815-1135
17181	Lineo 250	90-145	0.41-0.63	201-400	136.5-364.8	723.6-1440
17197	Lineo 250 Q T	85-110	0.40-0.50	200-275	333.5-519.9	720-990
17182	Lineo 315	190-360	1.14-1.60	442-719	265.8-543.3	1591.2-2588.4

Lineo Quiet



- Mixed flow in-line fan
- Co-moulded shell for easy removal during maintenance
- Flow driver and straightening vanes to correct airflow
- Low noise levels due to passive dampener
- 2 speed
- IP45 Rated

Technical Details

Code	Model	Watts	Amps	l/s	Pa	m ³ /hr
		min-max	min-max	min-max	min-max	min-max
17160	Lineo 100 Quiet	11-27	0.09-0.13	41.7-72.2	88.3-147.1	150.1-259.9
17190	Lineo 100 T Quiet	11-27	0.09-0.13	41.7-72.2	88.3-147.1	150.1-259.9
17162	Lineo 150 Quiet	24-50	0.14-0.22	70.8-141.7	103-210.9	254.8-510.1
17192	Lineo 150 T Quiet	24-50	0.14-0.22	70.8-141.7	103-210.9	254.8-510.1
17164	Lineo 200 Quiet	50-95	0.34-0.49	223.6-322.2	202-284.4	804.9-1159.9
17194	Lineo 200 T Quiet	50-95	0.34-0.49	223.6-322.2	202-284.4	804.9-1159.9
17165	Lineo 250 Quiet	95-150	0.42-0.65	266.7-430.6	198.1-339.3	960.12-1550
17166	Lineo 315 Quiet	215-360	0.95-1.55	575-802.8	300.1-525.7	2070-2890



Lineo/Lineo Quiet Product Accessories

Code	Model	For Model
12987	C5 0.5 5 Speed Controller	17143-17144-17145-17146-17160-17161-17162
12966	C1.5 Electronic Speed Controller 1.5A	17143-17144-17145-17146-17180-17181-17160-17161-17162-17164-17165
12967	C2.5 Electronic Speed Controller 2.5A	17182-17166
22483	Flush Mounting Kit SCB5 for C0.5	12987
22481	Flush Mounting Kit SCB for C1.5/C2.5	12966-12967
12992	C Temp - Temperature Controller	17143-17144-17145-17146-17180-17181-17182-17160-17161-17162-17164-17165-17166
12993	C Smoke - Air Quality Sensor	17143-17144-17145-17146-17180-17181-17182-17160-17161-17162
12994	C HCS - Humidity Sensor	17143-17144-17145-17146-17180-17181-17182-17160-17161-1716
12998	C PIR- PIR Sensor	17143-17144-17145-17146-17180-17181-17182-17160-17161-17162
12999	C Timer - Adjustable Over Run Timer	17143-17144-17145-17146-17180-17181-17182-17160-17161-17162

Product Code Terminology

P	Pullcord
T	Timer
A	Auto Shutter
LL	LongLife
PIR	Passive Infrared
HCS	Humidity Control System
I	Inbuilt (Recessed)
R	Reversible
M	Metal
E	ERP Compliant
Q	Quiet
D	Dual Speed
TP	Timer Programable
ES	Energy Saving
V0	Self-Extinguishing Plastic
12V	12V Low Voltage Fan

Lineo ES

- Mixed flow in-line fan
- EC brushless motors
- Flexible install
- 2 speed
- 0 to 10 volts speed control signal
- IP45 Rated

Technical Details

Code	Model	Watts	Amps	l/s	Pa	m ³ /hr
		2V/4V/8V/10V	2V/4V/8V/10V	2V/4V/8V/10V	2V/4V/8V/10V	2V/4V/8V/10V
17159	Lineo 100 ES	6.5	0.7	38.9	36.3	140.0
		8.7	0.9	48.6	59.8	175.0
		16	0.15	69.4	111.8	249.8
		20	0.20	84.7	258.9	304.9
17179	Lineo 150 ES	11	0.10	80.6	83.4	290.2
		17	0.16	102.8	135.3	370.1
		34	0.30	138.9	222.6	500.0
		55	0.50	163.9	433.5	590.0
17167	Lineo 200 ES	15.8	0.19	155.6	90.2	560.2
		25.7	0.28	194.4	141.2	699.8
		52.8	0.53	255.6	235.4	920.2
		90	0.80	305.6	342.4	1100.2
17168	Lineo 250 ES	20	0.17	209.7	107.9	754.9
		35	0.28	259.7	165.7	934.9
		75	0.61	343.1	283.4	1235.2
		126	1.00	409.7	396.2	1474.9
17169	Lineo 315 ES	45	0.37	393.1	143.2	1415.2
		75	0.63	483.3	214.8	1739.9
		170	1.32	644.4	378.6	2319.8
		230	1.75	729.2	412.7	2625.1



Lineo Quiet ES

- Mixed flow in-line fan with EC brushless motor
- Co-moulded shell for easy removal during maintenance
- Flow driver and straightening vanes to correct airflow
- Low noise levels due to passive dampener
- 0 to 10 volts speed control signal
- 2 speed
- IP45 Rated

Technical Details

Code	Model	Watts	Amps	l/s	Pa	m ³ /hr
		2V/4V/8V/10V	2V/4V/8V/10V	2V/4V/8V/10V	2V/4V/8V/10V	2V/4V/8V/10V
17170	Lineo 100 Quiet ES	6.2	0.09	37.5	34.3	135
		8.3	0.12	48.6	56.9	175.0
		14.7	0.18	69.4	111.8	249.8
		23	0.26	83.3	243.2	299.9
17172	Lineo 150 Quiet ES	7.7	0.11	69.4	45.1	249.8
		10.6	0.14	84.7	73.6	304.9
		20	0.24	119.4	107.9	429.8
		31	0.34	143.1	237.3	515.2
17174	Lineo 200 Quiet ES	15.2	0.18	158.3	84.3	569.9
		25.3	0.27	200	136.3	720
		52.4	0.52	262.5	224.6	945
		88	0.78	318.1	329.5	1145.2
17175	Lineo 250 Quiet ES	20	0.19	208.3	99.1	749.9
		35	0.28	261.1	153	940.0
		75	0.60	347.2	260.9	1249.9
		125	0.97	412.4	367.8	1484.6
17176	Lineo 315 Quiet ES	42	0.31	388.9	126.5	1400.0
		72	0.51	480.6	191.2	1730.2
		155	1.10	638.9	331.5	2300.0
		220	1.52	730.6	379.5	2630.2

Lineo ES /Lineo Quiet ES Product Accessories

Code	Model	For Model
12828	POT 0-10 V Potentiometer	Suitable For All ES Models
12826	POT-IT 0-10 V Potentiometer	Suitable For All ES Models
22461	503 Recessed Mounting Box	Suitable For All ES Models
12992	C Temp - Temperature Controller	Suitable For All ES Models
12993	C Smoke - Air Quality Sensor	Suitable For All ES Models
12994	C HCS - Humidity Sensor	Suitable For All ES Models
12998	C PIR - PIR Sensor	Suitable For All ES Models
12999	C Timer - Adjustable Over Run Timer	Suitable For All ES Models

CA MD E



- Centrifugal in-line metal fan
- Backward curved impellers
- 3 speed
- Mounting brackets included
- IP44 Rated

The CA wall external D centrifugal duct fans, for outdoor applications. These fans are manufactured with a steel housing and painted with a polyester paint for long life in all weather conditions. These fans are ideal for ducted installations, have IP44/IPX4 protection, and are designed for domestic and commercial applications.

Technical Details

Code	Model	Watts	Amps	l/s	Pa	m ³ /hr
		min-max	min-max	min-max	min-max	min-max
16150	CA 100 MD	26-85	0.22-0.40	45-93	195-381	162-334.8
16163	CA 150 MD E	26-85	0.22-0.38	63-148	121-435	226.8-532.8
16165	CA 200 MD E	39-89	0.35-0.43	114-215	353-441	410.4-774
16166	CA 250 MD E	50-120	0.47-0.53	150-280	330-537	540-1008
16167	CA 315 MD E	50-120	0.47-0.53	158-281	353-544	568.8-1011.6

CA MD E Roof

- Centrifugal in-line metal fan
- Backward curved impellers
- 3 speed
- IP44 Rated

Technical Details

Code	Model	Watts	Amps	l/s	Pa	m ³ /hr
		min-max	min-max	min-max	min-max	min-max
16140	CA 100 MD E RF	12-50	0.13-0.23	26-73	272-389	93.6-262.8
16183	CA 150 MD E RF	33-85	0.33-0.39	63-136	307-432	226.8-489.6
16185	CA 200 MD E RF	33-95	0.33-0.42	86-194	313-440	309.6-698.4
16186	CA 250 MD E RF	48-130	0.47-0.57	106-236	384-552	381.6-849.6
16187	CA 315 MD E RF	48-130	0.48-0.57	102-240	368-573	367.2-864

Product Code Terminology

P	Pullcord	M	Metal
T	Timer	E	ERP Compliant
A	Auto Shutter	Q	Quiet
LL	LongLife	D	Dual Speed
PIR	Passive Infrared	TP	Timer Programable
HCS	Humidity Control System	ES	Energy Saving
I	Inbuilt (Recessed)	V0	Self-Extinguishing Plastic
R	Reversible	12V	12V Low Voltage Fan



CA V0 E



- Centrifugal in-line self extinguishing V0 plastic fan
- Backward curved impellers
- 3 speed
- Mounting brackets included
- IP44/IPX4 Rated

Technical Details

Code	Model	Watts	Amps	l/s	Pa	m3/hr
		min-max	min-max	min-max	min-max	min-max
16008	CA 100 V0 D	14-50	0.14-0.22	24-69	269-366	86.4-248.4
16028	CA 150 V0 D	14-52	0.14-0.22	41-128	83-312	147.6-460.8
16038	CA 200 V0 E	39-90	0.35-0.40	107-215	241-414	385.2-774
16039	CA 250 V0 E	45-90	0.37-0.40	145-237	218-373	522-853.2
16041	CA 315 V0 E	48-120	0.48-0.54	146-305	270-554	525.6-1098

CA Range Product Accessories

Code	Model	For Model
12891	Trio D Controller	For all models
12971	SCNRB Built In Controller	All Models
22481	Flush Mounting Kit SCB for C1.5/C2.5	for C1.5 and C2.5
22750	CA-G 100 Protection Grille	100 models
22760	CA-G 150 Protection Grille	150 models
22765	CA-G 200 Protection Grille	200 models
22770	CA-G 250 Protection Grille	250 models
22775	CA-G 315 Protection Grille	315 models
22551	Backdraught Shutter 100Ø	100 models
22562	Backdraught Shutter 150Ø	150 models
22566	Backdraught Shutter 200Ø	200 models
22571	Backdraught Shutter 250Ø	250 models
22576	Backdraught Shutter 315Ø	315 models

CA WE D External

- Centrifugal external wall fan
- Backward curved impellers
- 2 speed
- IPX5 Rated

Technical Details

Code	Model	Watts	Amps	l/s	Pa	m3/hr
		min-max	min-max	min-max	min-max	min-max
16091	CA 100 WE D	12-50	0.13-0.23	18-70	180-379	64.8-252
16087	CA 150 WE D E	38-100	0.36-0.44	59-173	267-446	212.4-622.8
16089	CA 200 WE D E	38-100	0.36-0.44	60-188	244-434	216-676.8

Nordik Ceiling Sweep Fan



- Ceiling sweep fan
- IP20

Nordik International Plus Range. Simple modern design that is suitable for any type of room or application. The model 160/60" is especially suitable for heat recirculation in industrial and commercial applications.

Technical Details

Code	Model	Watts	Amps	No Blades	Diameter
61701	Nordik Int Plus 1 90/36	70	0.32	3	900mm / 36"
61711	Nordik Int Plus 1 120/48	70	0.33	3	1200mm / 48"
61721	Nordik Int Plus 1 140/56	70	0.33	3	1400mm / 56"
61731	Nordik Int Plus 1 160/60	70	0.33	3	1600mm / 60"

Product Accessories

Code	Model	For Model
12955	5 Position Speed Controller	61701-61711-61721-61731
12967	C2.5 Electronic Speed Controller	61701-61711-61721-61731
22483	Recess kit for 12995	12955
22033	Down Rod W 250mm long	61701-61711-61721-61731
22051	Down Rod W 500mm long	61701-61711-61721-61731
22074	Down Rod W 750mm long	61701-61711-61721-61731
22077	Down Rod W 1000mm long	61701-61711-61721-61731

Gordon Fan



- Wall Mounted Oscillating Fan
- Remote Control
- 3 Speeds

Technical Details

Code	Model	Watts	Amps	m ³ /h
60643	Gordon W 30/12" ET	35	0.18	2400



Controllers and Environmental Sensors

Speed Controllers

Code	Vario Speed Controller	Box Qty
12943	CR5, 5 Speed Controller, On/Off. Reversible. Can be used to regulate more than one fan. Maximum load 100w Only suitable for Vario Range	6
Code	CA/Lineo Electronic Speed Controllers	Box Qty
12966	Electronic Speed Controller 1.5A For Models 100 Q V0 To 200 V0 Inclusive	6
12967	Electronic Speed Controller 2.5A For Models 250 V0 And 315 V0	6
MSC1.5	Electronic Speed Controller 1.5A	1
MSC3	Electronic Speed Controller 3A	1
MSC5	Electronic Speed Controller 5A	1



12943: 5 Speed Controller



12966.

Environmental Sensors

Code	Sensors For Vario & Lineo Range Fans	Box Qty
12994	Humidity Sensor Measures ambient relative humidity (R.H.), and starts the fan when the R.H. exceeds 65%. The sensor can also be wired to allow the unit to be switched on when the R.H. is below 65%, and incorporates an over-run timer (adjustable between 3 and 20 minutes).	1
12998	PIR-Movement Detector, Detects the presence of a moving body within its sensor range, and starts the fan automatically. The built-in over-run timer can be adjusted between 3 and 20mins	1
12999	Timer Adjustable overrun timer (adjustable between 3-20 mins).	1
12992	Temperature Measures ambient room temperature, and starts the fan when the temperature exceeds the present value. Once the temperature drops below the present value (adjustable between 10° and 40°C), the unit will over-run for between 3 and 20 minutes (dependent on setting).	1

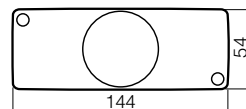



Industrial Ventilation

Vortice A-E Range 153

Table of Air Changes by Room Type 156





Vortical A-E Range

- Plate axial medium pressure axial fan
- Direct or ducted extraction
- IP54 Rated

Technical Details

Code	Model	Watts	Amps	m ³ /hr	Pa
Single phase					
42207	A-E 252 M	95	0.41	1365	177
42208	A-E 254 M	38	0.17	764	61
42216	A-E 304 M	81	0.35	1563	130
42258	A-E 354 M	170	0.75	2960	100
42260	A-E 404 M	300	1.33	4310	132
42307	A-E 454 M	270	1.19	5250	127
42316	A-E 504 M	482	2.12	6639	186
42337	A-E 506 M	290	1.27	4805	152
42356	A-E 566 M	350	1.60	6715	134
Three phase					
42357	A-E 254 T	50	0.22	785	134
42227	A-E 304 T	79	0.22	1696	129
42259	A-E 354 T	166	0.35	2980	115
42261	A-E 404 T	318	0.65	3832	246
42308	A-E 454 T	370	0.73	5187	155
42327	A-E 504 T	485	1.12	6966	128
42346	A-E 506 T	250	0.79	5040	96
42336	A-E 564 T	925	1.71	9255	285
42366	A-E 566 T	480	1.06	8050	175
42347	A-E 636 T	522	1.10	9502	154

Product Accessories*

Code	Model	For Model
52151	DPU Spacer Panel 250	42207-42208-42357
52251	DPU Spacer Panel 300	42216-42227
52351	DPU Spacer Panel 350	42258-42259
52451	DPU Spacer Panel 400	42260-42261
50150	PGR 250 Gravity Grille	42207-42208-42357
50250	PGR 300 Gravity Grille	42216-42227
50350	PGR 350 Gravity Grille	42258-42259
50450	PGR 400 Gravity Grille	42260-42261
50550	PGR 450/500 Gravity Grille	42307-42316-42337-42308-42327-42346
51150	TRA 250 Protection Grille	42207-42208-42357
51250	TRA 300 Protection Grille	42216-42227
51350	TRA 350 Protection Grille	42258-42259
51450	TRA 400 Protection Grille	42260-42261
51550	TRA 450/500 Protection Grille	42307-42316-42337-42308-42327-42346

*Non stock items, contact sales for lead time

[RETURN TO INDEX](#)

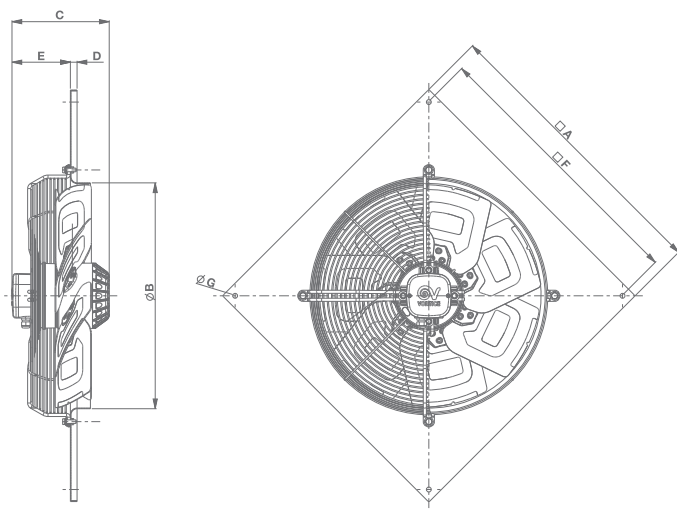

Dimensions (mm)

	A	B	C	D	E	F	G	F
A-E 252 M	320	264	149	10	82	280	8	2.1
A-E 254 M	320	264	149	10	82	280	8	2.1
A-E 254 T	320	264	149	10	82	280	8	2.5
A-E 304 M	380	216	151	10	84	330	8	3.0
A-E 304 T	380	316	151	10	84	330	8	3.4
A-E 354 M	450	359	155	10	43	380	8	4.0
A-E 354 T	450	359	155	10	43	380	8	4.0
A-E 404 M	450	406	200	15	75	430	12	6.1
A-E 404 T	510	406	207	15	67	430	12	6.3
A-E 454 M	630	455	200	15	60	530	12	6.3
A-E 454 T	630	455	207	15	67	530	12	6.3
A-E 504 M	630	507	218	15	72	530	11	13.2
A-E 504 T	630	507	198	15	52	530	11	11.1
A-E506 M	630	507	218	15	72	530	11	13.2
A-E 506 T	630	507	198	15	52	530	11	11.1
A-E 564 T	725	563	218	15	67	675	11	14.8
A-E 566 M	725	563	218	15	67	675	11	14.8
A-E 566 T	725	563	218	15	67	675	11	14.8
A-E 636 T	805	638	218	15	68	750	11	15.8



[RETURN TO INDEX](#)

Table of air changes per type of room

Suggested No. of Air Changes Per Hour	Air Changes per hour		
Residential Homes	Bathrooms	6-10	
	Bedrooms	2-4	
	Cellars	3-10	
	Kitchens - Domestic	10-20	
	Living Rooms	3-6	
	Utility Rooms	15-20	
Offices	Canteens	8-12	
	Conference Rooms	8-12	
	Entrance Halls and Corridors	3-5	
	Offices	6-10	
	Toilets	6-10	
Public Buildings	Assembly Rooms	4-10	
	Churches	1-3	
	Cinemas and Theatres	6-15	
	Dental Surgeries	12-15	
	Lavatories	6-15	
	Lecture Theatres	6-10	
	Libraries	3-5	
	Schoolrooms	4-7	
	Bars, Restaurants, Dance Halls	Banquet Halls	10-15
		Club Rooms	12-14
Hotel Bars		6-10	
Public House Bars		8-12	
Restaurants		8-15	
Dance Halls		12-14	
Shops and Stores	Bakeries	20-30	
	Banks/Building Societies	4-8	
	Cafés and Coffee Bars	10-15	
	Hairdressing Salons	10-15	
	Laundries	10-30	
	Shops and Stores	8-15	
	Sports Facilities	Billiard Rooms	6-8
Changing Rooms		6-10	
Gymnasiums		6-8	
Shower Rooms		15-20	
Squash Courts		4-6	
Industrial Premises	Boiler Rooms	15-30	
	Compressor Rooms	10-20	
	Dairies	8-10	
	Electroplating Shop	10-12	
	Engine Rooms	15-30	
	Factories and Workshops	6-10	
	Foundries	15-30	
	Glasshouses	45-60	
	Kitchens - Commercial	30 minimum	
	Laboratories	4-15	
	Mushroom Houses	6-10	
	Photo & X-ray Darkroom	10-15	
	Recording Studios Control Rooms	15-25	
	Recording Studios	10-12	
	Stores and Warehouses	3-6	
Welding Shops	15-30		

N.B. If smoking is allowed within the room, then it would be necessary to increase the number of suggested air changes above by 50%. Local regulations should always take precedence over the above suggested air change rates.

Easi Vent Ducting

Easi Vent Ducting & Accessories Rectangular	158
Easi Vent Ducting & Accessories Round	160
Easi Vent Ducting & Accessories Flexible	161
Wall Grilles	162
Ducting Accessories	163

Easi Vent Ducting & Accessories

The choice of rectangular systems depends on the air volume and speed at which the air is being expelled. The higher the volume and speed, the bigger the duct needed. For extractor fans or low powered cooker hoods, use Easi Vent 100. For whole house central extract systems or high powered cooker hoods, use Easi Vent 204.

Rectangular Ducting Specifications:

	Easi Vent 100 110mm x 54mm	Easi Vent 204 204mm x 60mm	
Dimensions			
Flat Channel 1.5m Length	VKC240	VKC5628	
Flat Channel 2m Length	VKC297	VKC5629	
Flat Channel Connector	VKC235	VKC5608	
Flat Channel Clip	VKC230	VKC5610	
45° Horizontal Bend	N/A	VKC5616	
90° Horizontal Bend	VKC238	VKC5605	
Flexible Bend Horizontal	VKC229	N/A	
45° Vertical Bend	N/A	VKC5617	
90° Vertical Bend	VKC239	VKC5612	
Short Round to Rectangular	VKC207	N/A	
Adaptor Male			



Rectangular Ducting Specifications:

	Easi Vent 100	Easi Vent 204
Dimensions	110mm x 54mm	204mm x 60mm
Short Round Rectangular Adaptor Female	VKC241	VKC5613
Elbow Bend with Spigot Male 90°	VKC237	N/A
Elbow Bend with Spigot Female 90°	VKC236	N/A
Fixed Elbow Bend 100mm Spigot	N/A	VKC5625
Fixed Elbow Bend 125mm Spigot	N/A	VKC5645
Rotating Elbow Bend 125mm Spigot	N/A	VKC5606
Rotating Elbow Bend 150mm Spigot	N/A	VKC5626
T-Piece	VKC228	VKC5630
Airbrick Adaptor 150mm Spigot	VKC247	N/A
Airbrick Grille Only	VKC704	N/A
Airbrick & Grille	VKC703	VKC5631



Easi Vent Ducting & Accessories Round

Round pipes form the perfect duct and we would recommend that round ducting systems are used wherever possible. Easi Vent round ducting is highly recommended for fans and cooker hoods with high output. It is also most suitable for long runs as in whole house ventilation, passive stack ventilation and air conditioning.

Round Ducting Specifications:

	Easi Vent 100	Easi Vent 125	Easi Vent 150
Dimensions	100mm	125mm	150mm
Round Pipe 1m	N/A	VKC267	VKC670
Round Pipe 1.5m	VKC299	N/A	VKC671
Round Pipe 2m	N/A	VKC2692	N/A
Round Connector	EK28	VKC355	VKC365
Round Connector with Damper	VKC303	VKC353	VKC363
45° Elbow Bend	VKC301	VKC351	N/A
90° Elbow Bend	VKC300	VKC350	VKC360
Equal T Piece	VKC302	VKC352	VKC362



Easi Vent PVC P Flexible Ducting Specifications:

A light wire-reinforced white PVC ducting for domestic applications including cooker hoods and bathroom fans. Standard pitch is 35mm, standard lengths and diameters are listed below.

Code	Description	Box Quantity
P0596/082/26	82mm White PVC Ducting 15m	20
P0092/102/35	102mm White PVC Ducting 3m	72
P0180/102/35	102mm White PVC Ducting 6m	36
P1310/102/35	102mm White PVC Ducting 45m	1
P0092/133/35	133mm White PVC Ducting 3m	48
P0180/133/35	133mm White PVC Ducting 6m	24
P0440/133/35	133mm White PVC Ducting 15m	8
P0180/152/35	152mm White PVC Ducting 6m	18

Flexible Aluminium Ducting Specifications:

Wire reinforced aluminium ducting with polyester coating for strength. Manufactured to BS476 Parts 6 & 7, Class 0.

Code	Description	Box Quantity
A10M / 102	102mm Aluminium Ducting 10m	1
A10M / 152	152mm Aluminium Ducting 10m	1
A10M / 203	203mm Aluminium Ducting 10m	1





Flexible Insulated Aluminium Ducting Specifications:

Aluminium ducting with 25mm glass wool insulation to minimise condensation when the ducting travels through a cold area such as a roof space. Manufactured to BS476 Parts 6 & 7, Class 0.

Code	Description	Box Quantity
INSUL / 102 / 10	102mm Insulated Alum Ducting 10m	1
INSUL / 127 / 10	127mm Insulated Alum Ducting 10m	1
INSUL / 152 / 10	152mm Insulated Alum Ducting 10m	1

Easi Vent Ducting & Accessories

Wall Grilles Specifications:

	Easi Vent Grilles 100mm	Easi Vent Grilles 125mm	Easi Vent Grilles 150mm	
Dimensions	4" 102mm	5" 125mm	6" 152mm	
Description				
Wall Outlet with Gravity Flaps and Round Spigot	VKC243W VKC243B	VKC270	VKC292W	
Round grille with Flyscreen White only	VKC256	N/A	N/A	
Wall Outlet with Louvred Grille Round Spigot	VKC244W	VKC268	VKC275	
Wall Outlet with Louvred Grille and Flyscreen Round Spigot	VKC244WF/S VKC244BLF/S	N/A	VKC275 WF/S	
Cowled Wall Outlet with Damper Round Spigot	VKC245W	VKC289		

KEY: W= White; B= Brown; BL= Black; F/S= Fly Screen;



Air Valves Specifications:

Code	Air Extract/Supply Valves Description	Box Quantity
EAV-K6	150mm Ceiling Air Valve Chrome	10
SS104	100mm Stainless Steel Ceiling Air Valve	5
VKC306F	100mm Ceiling Air Valve White PVC	25
VKC356F	125mm Ceiling Air Valve White PVC	10
VKC366F	150mm Ceiling Air Valve White PVC	16

Condensation Trap Specifications:

Code	Condensation Trap Description	Box Quantity
VKC434	102mm Condensation Trap with Overflow	10

Clips Specifications:

Code	Clips Description	Box Quantity
VKC262	55-170mm Hose Clip	100
VKC304	100mm Round Pipe Fixing Clip	100

Reducers Specifications:

Code	Reducers Description	Box Quantity
VKC437	150mm-100mm Reducer	30
VKC619	150mm-125mm Reducer	30
VKC603	125mm-100mm Reducer	40
VKC51	100mm-80mm Reducer	180

Duct Tape Specifications:

Code	Duct Tape Description	Box Quantity
VKC273	PVC Duct Sealing Tape 50mm x 33mm	1



Water Heaters and Boilers

Pacific Water Heaters	166
Installation information	170
Why Use ATC Unvented Water Heaters?	171
Instantaneous Water Heater	172
Presto Eco Boil	174



ATC **Pacific** Under Sink Water Heaters



W5-U



W10-U

Key Features Include:

- Includes pressure relief valve for safe and easy installation
- Energy efficient
- Available in 2 sizes: 5L & 10L
- Power indicator light
- External adjustable thermostat control
- Includes wall bracket
- Comes with protective anode rod for maximum tank life
- Quick recovery element

Ideal for: Offices, Canteens, Mobile Homes, Apartments and Workshops



This compact undersink water heater is the ideal solution for commercial applications and can supply a number of sinks, depending on hot water demand, without the need for special taps. A cost effective solution compared to traditional vented systems.

Technical Details

Product Code	W5-U	W10-U
Capacity (L / Gal)	5L / 1.1Gal	10L / 2.2Gal
Power Watts (W)	2000W	2000W
Voltage (V)	220-240V	220-240V
Frequency (Hz)	50 / 60 Hz	50 / 60Hz
Max Pressure (Bar)	8 Bar	8 Bar
Connections	1/2"	1/2"
Thermostat	External	External
Approvals	UKCA, CE, RoHS	UKCA, CE, RoHS
ERP Class	B	B
IP Rating	IPX4	IPX4

Dimensions

W5-U

Height A	285mm
Width B	240mm
Depth C	240mm

W10-U

Height A	300mm
Width B	340mm
Depth C	330mm

Expansion Vessels for Water Heaters

Code	Description	Box Qty
KIT-A	2L Expansion Vessel with 1/2 " BSP for 5L, 10L & 15L Water Heaters	1

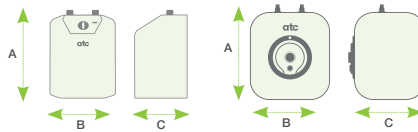

Recommended Selection Guide

Capacity of Water Heater	Number of Basins	Heat up time
5 litres	1 – 2	5 Litres – 11 mins*
10 litres	2 – 3	10 Litres – 19 mins*
15 litres	3 – 4	*10° to 65°C

Note: These figures are for guidance only.



Commercial



Hospitality



Residential



Sports & Leisure



Education



Healthcare



ATC **Pacific** Under Sink Water Heaters



W15-U

Key Features Include:

- Includes pressure relief valve for safe and easy installation
- Energy efficient
- Power indicator light
- External adjustable thermostat control
- Includes wall bracket
- Comes with protective anode rod for maximum tank life
- Quick recovery element

Ideal for: Offices, Canteens, Mobile Homes, Apartments and Workshops



Technical Details

Product Code	W15-U
Capacity (L / Gal)	14L / 3 Gallons
Power Watts (W)	2500W
Voltage (V)	220-240V
Frequency (Hz)	50 / 60 Hz
Max Pressure (Bar)	8 Bar
Connections	1/2"
Thermostat	External
Approvals	UKCA, CE, RoHs
ERP Class	B
IP Rating	IPX4

Dimensions

W15-U

Height A	337mm
Width B	364mm
Depth C	354mm

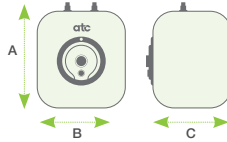

Expansion Vessels for Water Heaters

Code	Description	Box Qty
KIT-A	2L Expansion Vessel with 1/2 " BSP for 5L, 10L & 15L Water Heaters	1

Recommended Selection Guide

Capacity of Water Heater	Number of Basins	Heat up time
5 litres	1 – 2	14 litres - 22 mins*
10 litres	2 – 3	*10° to 65°C
15 litres	3 – 4	

Note: These figures are for guidance only.



Commercial



Hospitality



Residential



Sports & Leisure



Education



Healthcare



Parts and Technical Support Only

Installation Information

Installation of commercial unvented water heaters and kit options

For Inlet water pressure up to 4.1 bar.

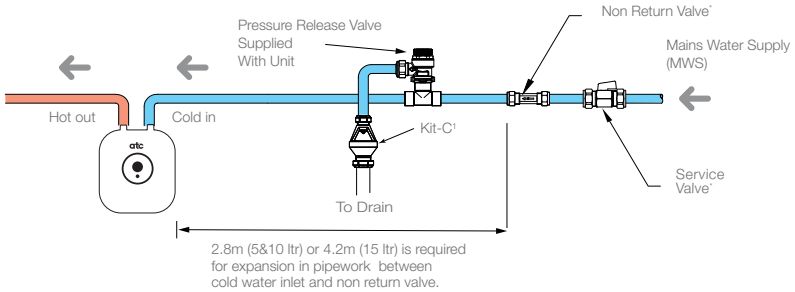

For Inlet water pressure up to 4.1 bar where expansion in the mains is not possible.

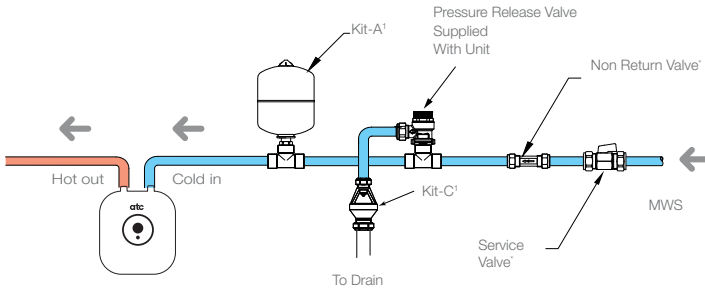

For Inlet water pressure over 4.1 bar

Note: If a pressure reducing valve is used then allowing for expansion in the pipework is not possible. An expansion vessel must be used.

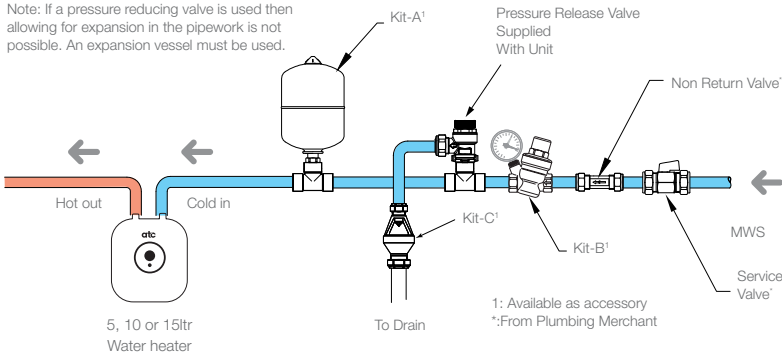



Why Use ATC Unvented Water Heaters?

Energy Efficient

- Fitted with Polyurethane Foam Insulation that reduces heat loss, which Reduces Energy consumption and ensures High Energy Efficiency
- External Thermostat Control with Economy setting for Energy Efficiency
- High performance 2KW square flange heating element which is more Durable and Efficient

Tough and Durable

- Unique Dry Porcelain Enamel Tank lining delivers at least twice the Corrosion Resistance of ordinary glass lining
- Fitted with a Premium Protective Magnesium Anode which equalises aggressive water action and provides Extra Protection against Corrosion

Safety

- Fitted with Thermostat and Limiting Device to protect against overheating

ATC Instantaneous Water Heater



Key Features Include:

- Easy to install
- Energy efficient
- ON / OFF switch – 3 heat options
- Wall mounted – reinforced bracket with internal steel bar
- External casing – made from strong ABS plastic
- Capillary thermostat
- No stored water avoiding legionella



This compact instantaneous water heater provides instant hot water for the smallest of spaces. Only heats water when required, making it a very energy efficient option.

Technical Details

Product Code	INST5.7
Power	5.7kW (2.5+3.2)
Voltage	220 - 240 Vac
Frequency	50/60Hz
Min Water Flow Rate	2 l/m
Min Water Pressure	80 kPa
Max Water Pressure	0.6 Mpa
Water Connection	15mm dia (1/2" BSP)
IP Rating	IPX4
ERP Rating	B

Dimensions

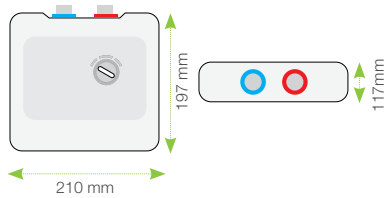

Commercial



Hospitality



Residential



Sports & Leisure



Education



Healthcare

UK
CA CE



Parts and Technical
Support Only

ATC Presto Ecoboil Water Boiler



Key Features Include:

- Easy to install
- Energy saving of up to 75% when compared to other conventional means of boiling water
- Wall mounted – no loose boiling water units on counter tops to prevent scalding
- Stainless steel finish – easy to keep clean, bacteria free and hygienic
- Steam free – no dangerous hot steam expelled from the unit
- Efficient filling method – saves electricity & time by filling in stages



Wall mounted, instant boiling water dispenser, perfect for locations such as offices, schools, hospitals, and factories.

Technical Details

Product Code	PRESTO 5S	PRESTO 7.5S
Capacity (litres)	5	7.5
Initial draw-off (180ml cups)	30	45
Recovery per minute (180ml cups)	2	2
First hour delivery (180ml cups)	135	150
Time for 1st cup (min)	7	7
Heating element (kw)	2.0	2.0
Min. supply pressure (kPa)	20	20
Max. supply pressure (kPa)	1000	1000
Weight	8.5kg	8.7kg
Dimensions (WxHxD)	320 x 448 x 195	320 x 448 x 195



Commercial



Hospitality



Residential



Sports & Leisure



Education



Parts and Technical Support Only



Heating Design Service

Bespoke Heating Design

178



Bespoke Heating Design

At ATC we offer a comprehensive range of Heating Design Services, catering to everyone from contractors to specifiers to sector-specific clients. We strive to ensure that you're securing the best heating solutions for your new build or renovation. We have a breadth of experience working on projects across a variety of sectors including:



Commercial



Hospitality



Residential



Sports & Leisure



Education



Healthcare

Review Criteria

It's important to review certain criteria in order to get the most energy efficient and comfortable method of heating in place.

These include:

- Room dimensions
- Glazed areas
- Insulation levels
- Heat levels in adjacent areas

Our dedicated Heating Design Team provides a full heating design to determine the correct solution for your building.

What's Involved

To provide an accurate heating design quotation, our team of experts will...

- Calculate the area & volume of each space
- Determine the amount of energy required to heat the area
- Confirm the type and amount of heaters that should be installed

Send your CAD drawing or sketch & dimensions to technical@atc.ie



We cater to

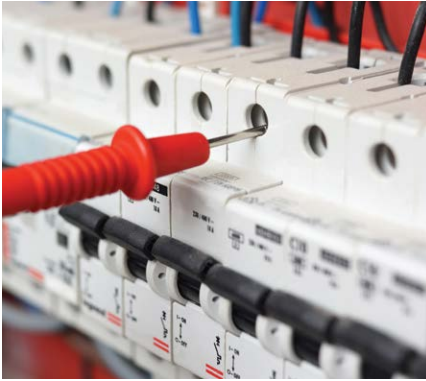

Contractors



Specifiers



General Public



Sector-Specific

Brochure Range

Explore our range of eBrochures available to view online or download!

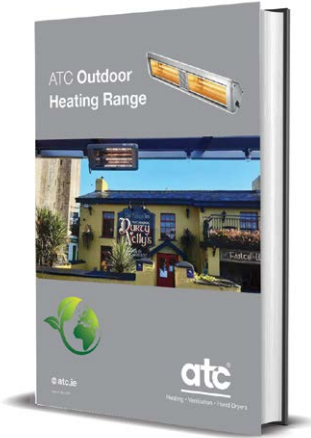

Outdoor Heating



Education Buildings Solutions



iLifestyle



Summary Brochure

Visit atc.ie/brochures

Next Day Delivery Across Ireland*



353 (1) 467 8301 | sales@atc.ie | [🌐 atc.ie](https://www.atc.ie)

*For orders placed by 2.30pm

Find your Local Sales Representative

Visit **atc.ie/contact**

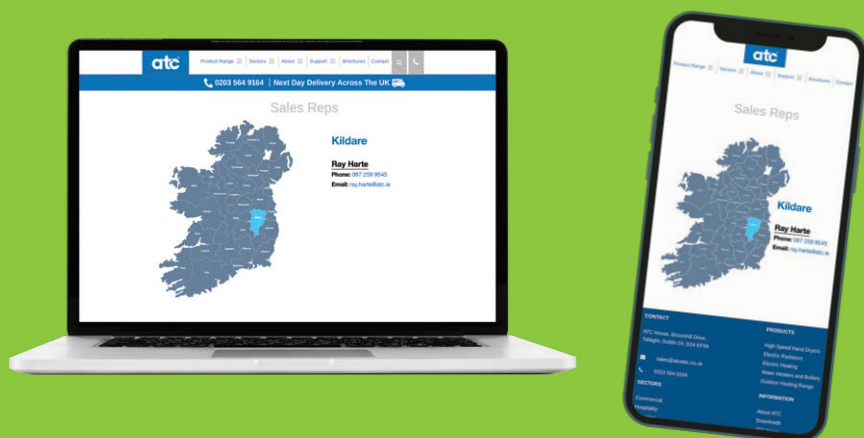

Contact **sales@atc.ie**
to find your local stockist

Spare Parts Listing

Model	Spare Part	Description
Cub High Speed	Z-2651-PCB	Cub High Speed PCB
	Z-2651-ELEMENT	Cub High Speed Element
	Z-2651-MOTOR	Cub High Speed Motor
	Z-2651-BRACKET	Cub High Speed Bracket
	Z-2651-SENSOR	Cub High Speed Sensor
	Z-2651M-BRUSHES	Cub High Speed Pair of Brushes
	Z-2651M-COVER	Cub High Speed Matt Stainless Steel cover
	Z-2651BL-COVER	Cub High Speed Black Stainless Steel cover
	Z-2651WH-COVER	Cub High Speed White Stainless Steel cover
Z-2651-FILTER	Filter for Cub High Speed Hand Dryers	
Cheetah	Z-2281-PCB2	Cheetah PCB inc Sensor
	Z-2281-ELEMENT	Cheetah Element
	Z-2281-MOTOR	Cheetah Motor
	Z-2281-BRUSHES	Pair of Brushes for Cheetah motor
	Z-2281M-COVER	Cheetah Cover Matt Brushed Steel
	Z-2281W-COVER	Cheetah Cover White
Tiger ECO	Z-3145-BRUSHES	Pair of Longlife Brushes for Tiger Eco Hand Dryer
	Z-3145-DUST	Dust Filter for Tiger ECO
	Z-3145-HEPA	HEPA Filter for Tiger ECO
	Z-3145-ELEMENT	Element for Tiger ECO Hand Dryer
	Z-3145M-COVER	Stainless steel cover for Tiger ECO
	Z-3145W-COVER	White cover for Tiger ECO
	Z-3145-MOTOR	Motor for Tiger ECO
Z-3145-PCB	PCB for Tiger ECO complete with Sensor	
Puma	Z-2000M-PCB	Puma PCB
	Z-2000M-ELEMENT	Puma Element
	Z-2000M-MOTOR	Puma Motor
	Z-2000M-BRUSHES	Pair of Puma Brushes
	Z-2000M-COVER	Puma Cover
	Z-2000M-FILTER	Puma Filter
Panther ECO	ATC-ZA01-COVER	White Cover for ZA01 Panther
	ATC-ZA05-COVER	Stainless steel Cover for ZA05 Panther and PANZA06
	ATC-ZA05-BRUSHES	Pair of Brushes
	ATC-ZA05-MOTOR	ATC High Speed Hand Dryer Motor ZA01 & ZA05 Panther
	VERSION 6 - PANTHER	PCB & SENSORS - ZA01 & ZA05 Panther

Model	Spare Part	Description
Long Life Panther Panza06	PANZA06-BRUSHES	Pair of brushes for PANZA06
	PANZA06-ELEMENT	Element - PANZA06 Panther
	PANZA06-PCB 2	PCB & Sensor - PANZA06 Panther
	FILTER-ASSEMBLY-PLASTIC	Panther Filter incl active carbon and 3M filter
	HEPA-PANTHER	Hepa Filter for Panther & Steel housing
Premblade15	PREM-PCB-MK1	Premblade15 PCB Board for Dryers made prior to April 2019
	PREM-PCB-MK2	Premblade15 PCB Board for Dryers made after August 2019
	PREM-BRUSH	Cleaning Brush for Premblade15
	PREM-START-BOARD	Start Board for Premblade15 Hand Dryer
	PREM-STOP-BOARD	Stop Board for Premblade15 Hand Dryer
	PREM-ELEMENT	Premblade15 Element
	PREM-MOTOR	Premblade15 Motor
	PREM-TOPCOVER	Top Cover for Premblade15
	PREM-FRONT-COVER	Front Cover for Premblade15
	HEPA-FILTER-BLADES	HEPA Filter for Premblade 15
	PREM-DUST-FILTER	Dust Filter for Premblade
PREM-WATERTRAY	Water tray for Premblade	
GS-Blade	GS-2006H-PCB-MARK1	PCB for ATC GS-Blade Mark 1
	GS-2006H-PCB-MARK3	PCB for ATC GS-Blade Mark 3
	GS-2006H-START-BOARD	Start Board for GS-Blade Hand Dryer
	GS-2006H-STOP-BOARD	Stop Board for GS-Blade Hand Dryer
	GS-2006H-ELEMENT	Element for GS-Blade Hand Dryer
	GS-2006H-MOTOR	Motor for ATC GS-Blade Hand Dryer
	GS-2006H-FRONT COVER-SLV	Front Cover for GS-Blade Hand Dryer
	GS-2006H-FILTER	Filter for ATC GS-Blade
	GS-2006H-WATERTRAY	Water Tray for ATC GS-Blade Dryer
	GS-2006H-EMI-FILTER	EMI Filter for ATC GS-Blade
	GS-2006H-PFC-FILTER	PFC Filter for ATC GS-Blade Dryer
	GS-2006H-BACK COVER	Back Cover for GS-Blade Hand Dryer
	GS-2006H-BRACKET	Bracket for GS-2006H

Model	Spare Part	Description
Eco-Blade	VERSION 4-ECOMO-22	Round ECO-Blade& Sensor Version 4
	VERSION 4-NEW-ECOMO-12	Square ECO-Blade PCB & Sensor Version 4
	HEPA-FILTER	ECO-Blade HEPA Filter
Water Heating	W5-GASKET	Element Gasket W5-U only
	W10-ANODE	Magnesium Anode W5-U & W10-U
	W10-GASKET	Element Gasket W10-U & W15U
	W15-ANODE	Magnesium Anode W15-U only
Presto Boilers	FP-ELE-2-0	PRESTO 2KW ELEMENT
	FP-PCB	PRESTO PC BOARD
	FP-VALVKIT	PRESTO SOLENOID VALVE KIT
	FP-TAP-O/ASS	PRESTO TAP ASSEMBLY
	FP-PROBE-5	PRESTO LOW LEVEL PROBE 5LT
	FP-PROBE-7-5	PRESTO LOW LEVEL PROBE 7.5LT
	FP-PROBE-10	PRESTO LOW LEVEL PROBE 10LT
	FP-THERMIS	PRESTO THERMISTOR
Lifestyle Radiators	CASTORS	Pair of Castors for iLifestyle, Lifestyle & Varena
	LS-METAL-BRACKETS	Pair of Brackets for iLifestyle, Lifestyle & Varena
	LS-BRACKET-COVER	Plastic covers for Metal Brackets 1 set required per pair of brackets
	LS-LEFT-CASE	Lifestyle Left Plastic Casing
	LS-RIGHT-CASE	Lifestyle Right Case c/w Electronics
iLifestyle Connected Radiators	CASTORS	Pair of Castors for iLifestyle, Lifestyle & Varena
	LS-METAL-BRACKETS	Pair of Brackets for iLifestyle, Lifestyle & Varena
	LS-BRACKET-COVER	Plastic covers for Metal Brackets 1 set required per pair of brackets
	WLS-LEFT-CASE	iLifestyle Left Plastic Casing - NO electronics
	WLS-RIGHT-CASE	iLifestyle Right Case c/w Electronics
Varena Radiators	CASTORS	Pair of Castors for iLifestyle, Lifestyle & Varena
	LS-METAL-BRACKETS	Pair of Brackets for iLifestyle, Lifestyle & Varena
	LS-BRACKET-COVER	Plastic covers for Metal Brackets 1 set required per pair of brackets
	C43022901	Varena Right casing c/w electronics

Model	Spare Part	Description
RF Sun Ray Radiators		
	E0500669	RF Complete End Panel With Electronics (For RF500-RF1500)
	E0500671	RF Complete End Panel With Electronics (For RF1800W)
	E0500626	WF Complete End Panel With Electronics (For WF500-WF1500)
	E0500627	WF Complete End Panel With Electronics (For WF1800W)
	RF-BRACKETS	Single bracket for RF Radiators - 2 req 350 to 1200, 3 req for 1500& 1800
	RF-FEET	Floor Mounting kit for RF Radiators
	RF-KIT	2 Plastic Wall Brackets, 1 Locking Bracket
	RF-SLIDING-BRACKET	RF Sliding Bracket
Original Sun Ray Radiators		
	CASTORS	Pair of Castors for Original Sunray & Sunray Plus
	LS-METAL-BRACKETS	Pair of Brackets for Original Sunray & Sunray Plus
	LS-BRACKET-COVER	Plastic covers for Metal Brackets 1 set required\ per pair of brackets
	SEND-COMplete	Analogue Control Panel for Sunray C/W Electronics
	SPEND-COMplete	Sunray Plus Right Plastic Casing Assembly C/W Electronics
Merida Radiators		
	MER500/750 BRACKET	MER500/750 Bracket
	MER1000 BRACKET	MER1000 Bracket
	MER1500 BRACKET	MER1500 Bracket
	MER2000 BRACKET	MER2000 Bracket
	MER-CONTROL	Merida Control Box complete
Almeria DPH Panel Heaters		
	DPH500/750 ECO BRACKET	DPH500/750 Eco Bracket
	DPH1000-ECO BRACKET	DPH1000 Eco Bracket
	DPH1500-ECO BRACKET	DPH1500 Eco Bracket
	DPH2000-ECO BRACKET	DPH2000 Eco Bracket
Alfresco Outdoor Heaters		
	ALH1800-BRACKET	Wall Bracket for ALH1800 ONLY
	002781	1800w Lamp for 767P, ALH1800 and ALH1800-P-Tri
	TRIPOD-ALFRESCO	Tripod for Alfresco
	TRIPOD-BRACKET	Bracket for Alfresco Tripod

Model	Spare Part	Description
Varma Outdoor Heaters	VARMALAMP2KW-IPX5	Halogen Lamp for all Varma IP X5 models
	VARMALAMP2KW	Halogen Lamp for Varma non IP models
Riveria Outdoor Heaters	RIV2KW-Lamp	Spare Lamp for all Riviera outdoor heaters
	RIV200-BRACKET	Bracket for RIV200
	RIV400-BRACKET	Bracket for RIV400/600
	RIV - Grille	Replacement Grille for RIV Heaters
Sienna Outdoor Heaters	SIE2.2KW-LAMP	Spare Lamp for Sienna 2.2KW
	SIE2.2KW-GRILLE	Replacement Grille for Sienna 2.2kw 000097401
	SIE4KW-LAMP	Spare Lamp for Sienna 4KW
INFRA4400	INFRA4400-REMOTE	Replacement remote control for INFRA4400
Welcome Overdoor Heater	REMOTE CONTROL	ODH Remote Control
Towel Rails	TRC-BRACKET	Brackets for Chrome straight non RF Towel Rail
	TRW-BRACKET	Brackets for White straight non RF Towel Rail
	RFTRW-BRACKET	Brackets for White RF Towel Rail
Underfloor Heating	ETF199	Universal Floor Sensor for OJ & HS500 underFloor Heating Thermostats
	REPAIRKIT	Repair Kit for Underfloor heating mats

Head Office & Showrooms:

ATC House,

Broomhill Drive,
Tallaght, Dublin 24
Ireland, D24 EF99

Tel: 353 (1) 467 8301

Fax: 353 (1) 452 0887

Email: sales@atc.ie

Business Hours:

Monday - Thursday: 8.30 - 17.00

Friday: 8.30 - 16.00

atc.ie



**QUALITY APPROVED
COMPANY**

Issue 8

atc[®]

